

International
IR Rectifier

IRG4BC20FD

INSULATED GATE BIPOLAR TRANSISTOR WITH
ULTRAFAST SOFT RECOVERY DIODE

Fast CoPack IGBT

Features

- Fast: optimized for medium operating frequencies (1-5 kHz in hard switching, >20 kHz in resonant mode).
- Generation 4 IGBT design provides tighter parameter distribution and higher efficiency than Generation 3
- IGBT co-packaged with HEXFRED™ ultrafast, ultra-soft-recovery anti-parallel diodes for use in bridge configurations
- Industry standard TO-220AB package

Benefits

- Generation -4 IGBTs offer highest efficiencies available
- IGBTs optimized for specific application conditions
- HEXFRED diodes optimized for performance with IGBTs. Minimized recovery characteristics require less/no snubbing
- Designed to be a "drop-in" replacement for equivalent industry-standard Generation 3 IR IGBTs

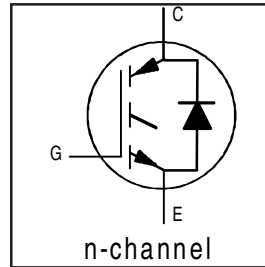

$V_{CES} = 600V$
$V_{CE(on) typ.} = 1.66V$
@ $V_{GE} = 15V, I_C = 9.0A$

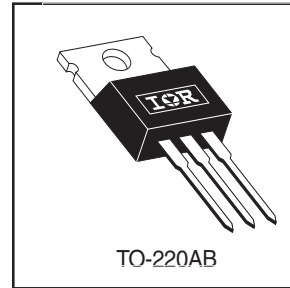

Absolute Maximum Ratings

	Parameter	Max.	Units
V_{CES}	Collector-to-Emitter Voltage	600	V
$I_C @ T_C = 25^\circ C$	Continuous Collector Current	16	A
$I_C @ T_C = 100^\circ C$	Continuous Collector Current	9.0	
I_{CM}	Pulsed Collector Current ①	64	
I_{LM}	Clamped Inductive Load Current ②	64	
$I_F @ T_C = 100^\circ C$	Diode Continuous Forward Current	7.0	
I_{FM}	Diode Maximum Forward Current	32	
V_{GE}	Gate-to-Emitter Voltage	± 20	V
$P_D @ T_C = 25^\circ C$	Maximum Power Dissipation	60	W
$P_D @ T_C = 100^\circ C$	Maximum Power Dissipation	24	
T_J	Operating Junction and	-55 to +150	$^\circ C$
T_{STG}	Storage Temperature Range		
	Soldering Temperature, for 10 sec.	300 (0.063 in. (1.6mm) from case)	
	Mounting Torque, 6-32 or M3 Screw.	10 lbf•in (1.1 N•m)	

Thermal Resistance

	Parameter	Min.	Typ.	Max.	Units
$R_{\theta JC}$	Junction-to-Case - IGBT	—	—	2.1	$^\circ C/W$
$R_{\theta JC}$	Junction-to-Case - Diode	—	—	3.5	
$R_{\theta CS}$	Case-to-Sink, flat, greased surface	—	0.50	—	
$R_{\theta JA}$	Junction-to-Ambient, typical socket mount	—	—	80	
Wt	Weight	—	2 (0.07)	—	g (oz)

www.irf.com

1

7/11/2000

IRG4BC20FD

International
IR RectifierElectrical Characteristics @ $T_J = 25^\circ\text{C}$ (unless otherwise specified)

	Parameter	Min.	Typ.	Max.	Units	Conditions
$V_{(BR)CES}$	Collector-to-Emitter Breakdown Voltage ^③	600	—	—	V	$V_{GE} = 0V, I_C = 250\mu A$
$\Delta V_{(BR)CES}/\Delta T_J$	Temperature Coeff. of Breakdown Voltage	—	0.72	—	V/ $^\circ\text{C}$	$V_{GE} = 0V, I_C = 1.0mA$
$V_{CE(on)}$	Collector-to-Emitter Saturation Voltage	—	1.66	2.0	V	$I_C = 9.0A$ $I_C = 16A$ $I_C = 9.0A, T_J = 150^\circ\text{C}$ $V_{GE} = 15V$ See Fig. 2, 5
		—	2.06	—		
		—	1.76	—		
$V_{GE(th)}$	Gate Threshold Voltage	3.0	—	6.0		$V_{CE} = V_{GE}, I_C = 250\mu A$
$\Delta V_{GE(th)}/\Delta T_J$	Temperature Coeff. of Threshold Voltage	—	-11	—	mV/ $^\circ\text{C}$	$V_{CE} = V_{GE}, I_C = 250\mu A$
g_{fe}	Forward Transconductance ^④	2.9	5.1	—	S	$V_{CE} = 100V, I_C = 9.0A$
I_{CES}	Zero Gate Voltage Collector Current	—	—	250	μA	$V_{GE} = 0V, V_{CE} = 600V$ $V_{GE} = 0V, V_{CE} = 600V, T_J = 150^\circ\text{C}$
		—	—	1700		
V_{FM}	Diode Forward Voltage Drop	—	1.4	1.7	V	$I_C = 8.0A$ $I_C = 8.0A, T_J = 150^\circ\text{C}$ See Fig. 13
		—	1.3	1.6		
I_{GES}	Gate-to-Emitter Leakage Current	—	—	± 100	nA	$V_{GE} = \pm 20V$

Switching Characteristics @ $T_J = 25^\circ\text{C}$ (unless otherwise specified)

	Parameter	Min.	Typ.	Max.	Units	Conditions
Q_g	Total Gate Charge (turn-on)	—	27	40	nC	$I_C = 9.0A$ $V_{CC} = 400V$ $V_{GE} = 15V$ See Fig. 8
Q_{ge}	Gate - Emitter Charge (turn-on)	—	4.2	6.2		
Q_{gc}	Gate - Collector Charge (turn-on)	—	9.9	15		
$t_{d(on)}$	Turn-On Delay Time	—	43	—	ns	$T_J = 25^\circ\text{C}$ $I_C = 9.0A, V_{CC} = 480V$ $V_{GE} = 15V, R_G = 50\Omega$ Energy losses include "tail" and diode reverse recovery. See Fig. 9, 10, 18
t_r	Rise Time	—	20	—		
$t_{d(off)}$	Turn-Off Delay Time	—	240	360		
t_f	Fall Time	—	150	220		
E_{on}	Turn-On Switching Loss	—	0.25	—	mJ	$T_J = 150^\circ\text{C}$, See Fig. 11, 18 $I_C = 9.0A, V_{CC} = 480V$ $V_{GE} = 15V, R_G = 50\Omega$ Energy losses include "tail" and diode reverse recovery.
E_{off}	Turn-Off Switching Loss	—	0.64	—		
E_{ts}	Total Switching Loss	—	0.89	1.3		
$t_{d(on)}$	Turn-On Delay Time	—	41	—	ns	$T_J = 150^\circ\text{C}$, See Fig. 11, 18 $I_C = 9.0A, V_{CC} = 480V$ $V_{GE} = 15V, R_G = 50\Omega$ Energy losses include "tail" and diode reverse recovery.
t_r	Rise Time	—	22	—		
$t_{d(off)}$	Turn-Off Delay Time	—	320	—		
t_f	Fall Time	—	290	—		
E_{ts}	Total Switching Loss	—	1.35	—	mJ	
L_E	Internal Emitter Inductance	—	7.5	—	nH	Measured 5mm from package
C_{ies}	Input Capacitance	—	540	—	pF	$V_{GE} = 0V$ $V_{CC} = 30V$ $f = 1.0MHz$ See Fig. 7
C_{oes}	Output Capacitance	—	37	—		
C_{res}	Reverse Transfer Capacitance	—	7.0	—		
t_{rr}	Diode Reverse Recovery Time	—	37	55	ns	$T_J = 25^\circ\text{C}$ See Fig. 14 $T_J = 125^\circ\text{C}$ 14
		—	55	90		
I_{rr}	Diode Peak Reverse Recovery Current	—	3.5	5.0	A	$T_J = 25^\circ\text{C}$ See Fig. 15 $T_J = 125^\circ\text{C}$ 15
		—	4.5	8.0		
Q_{rr}	Diode Reverse Recovery Charge	—	65	138	nC	$T_J = 25^\circ\text{C}$ See Fig. 16 $T_J = 125^\circ\text{C}$ 16
		—	124	360		
$di_{(rec)M}/dt$	Diode Peak Rate of Fall of Recovery During t_b	—	240	—	A/ μs	$T_J = 25^\circ\text{C}$ See Fig. 17 $T_J = 125^\circ\text{C}$ 17
		—	210	—		

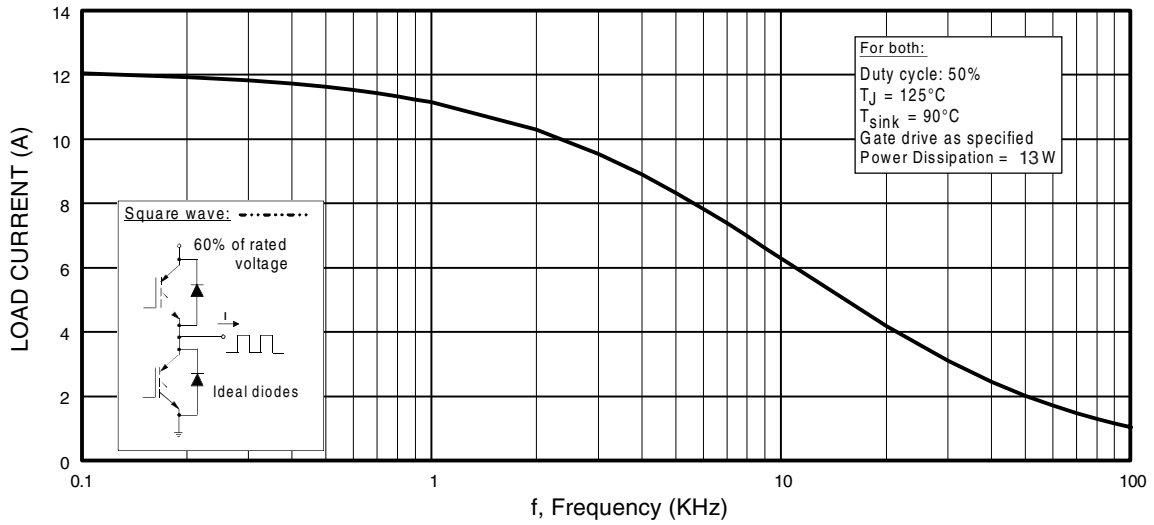

Fig. 1 - Typical Load Current vs. Frequency
(Load Current = I_{RMS} of fundamental)

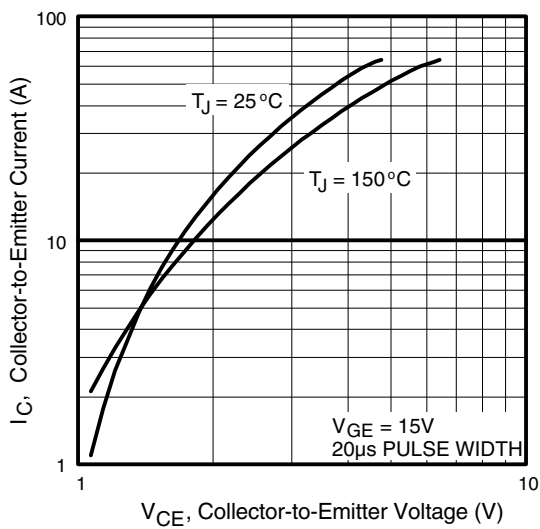

Fig. 2 - Typical Output Characteristics
www.irf.com

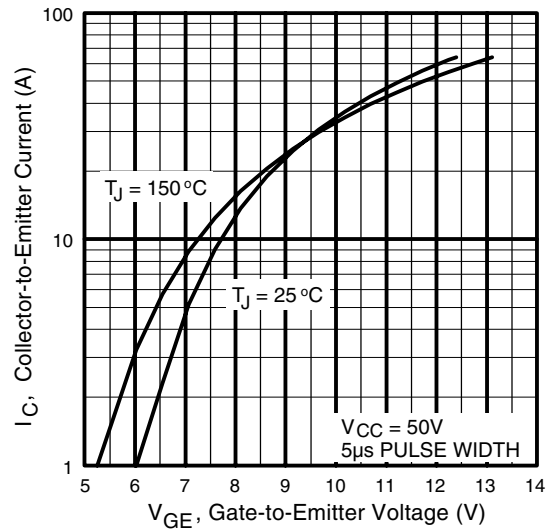

Fig. 3 - Typical Transfer Characteristics

IRG4BC20FD

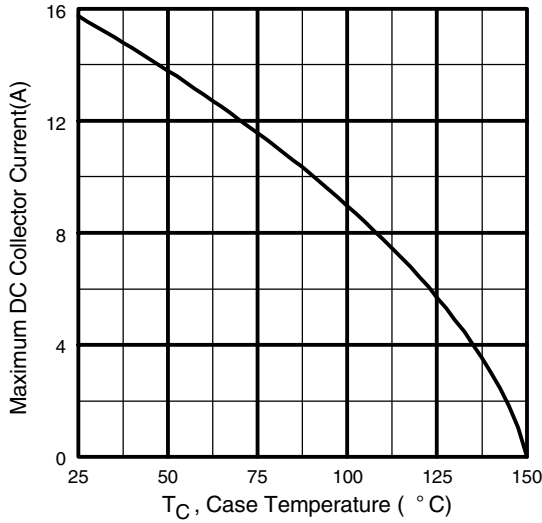

Fig. 4 - Maximum Collector Current vs. Case Temperature

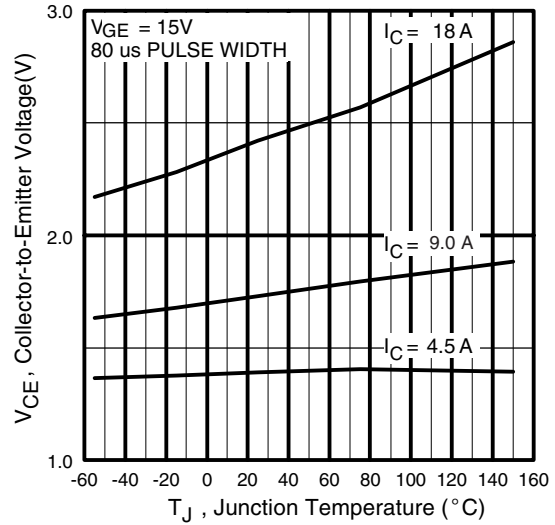

Fig. 5 - Typical Collector-to-Emitter Voltage vs. Junction Temperature

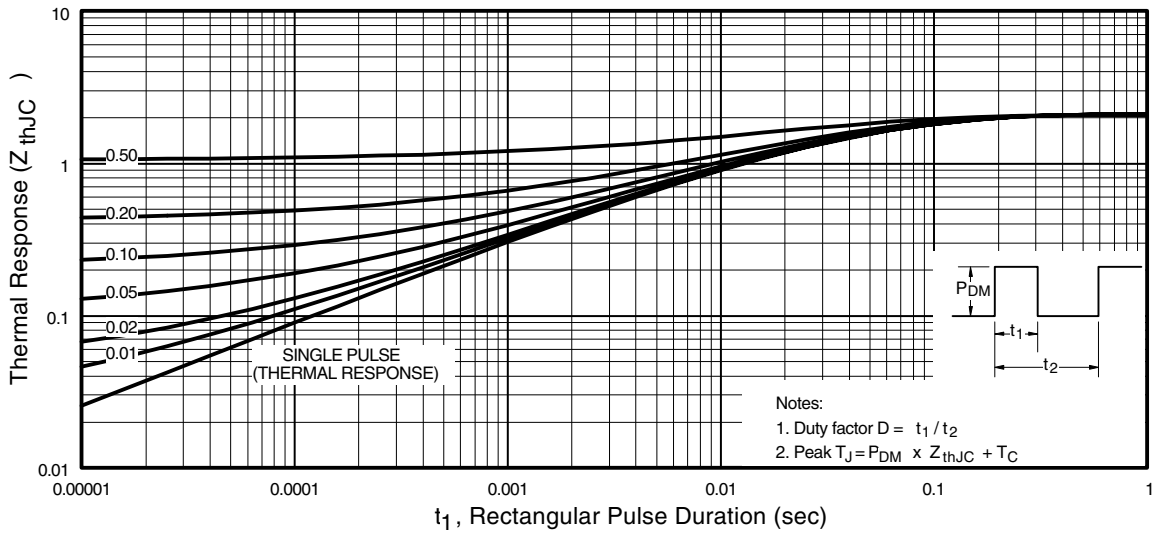

Fig. 6 - Maximum Effective Transient Thermal Impedance, Junction-to-Case

IRG4BC20FD

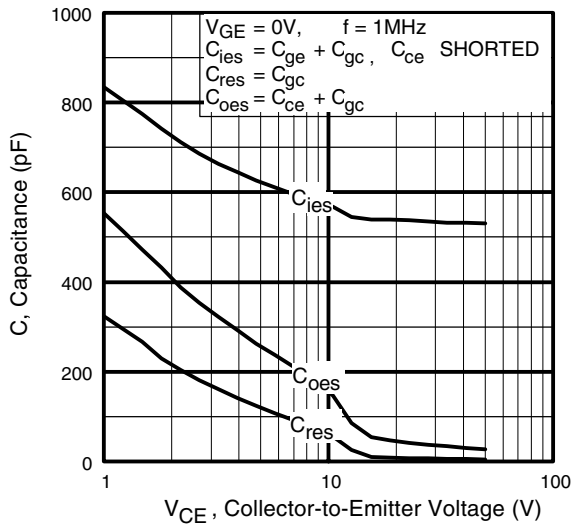

Fig. 7 - Typical Capacitance vs. Collector-to-Emitter Voltage

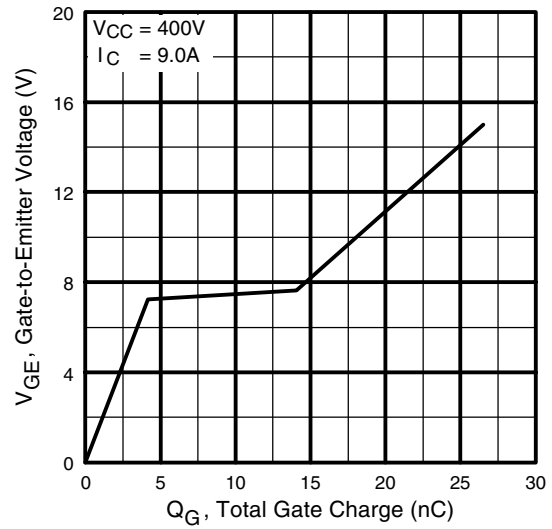

Fig. 8 - Typical Gate Charge vs. Gate-to-Emitter Voltage

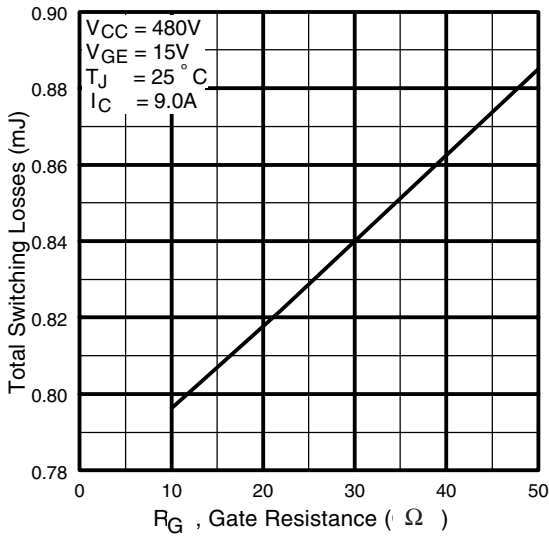

Fig. 9 - Typical Switching Losses vs. Gate Resistance

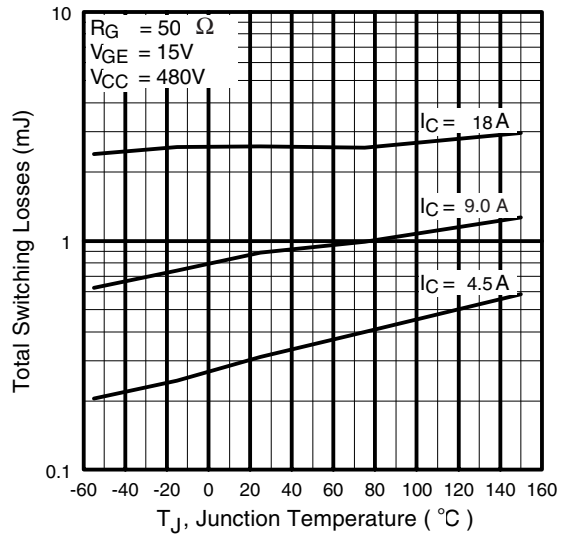

Fig. 10 - Typical Switching Losses vs. Junction Temperature

IRG4BC20FD

International
IR Rectifier

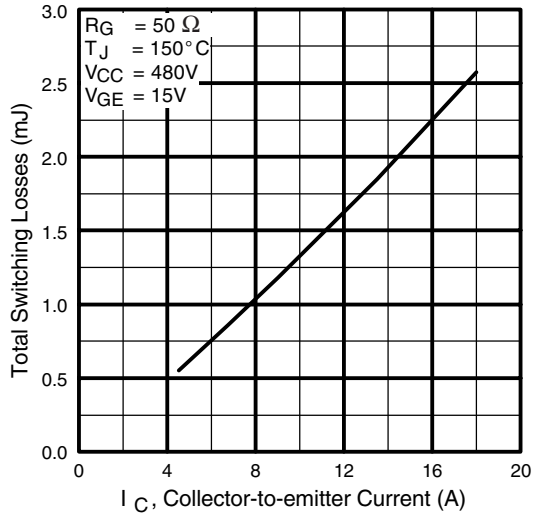

Fig. 11 - Typical Switching Losses vs. Collector-to-Emitter Current

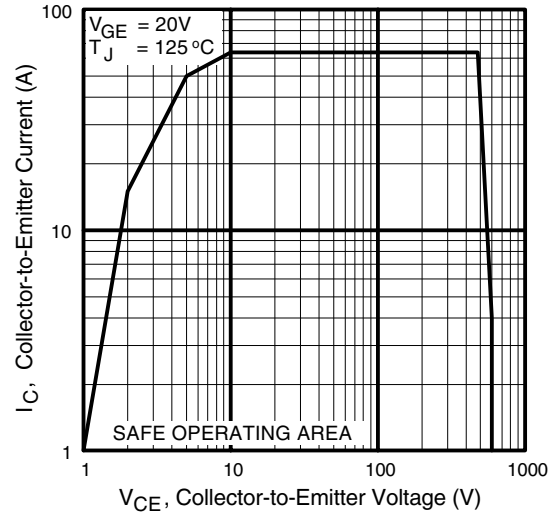

Fig. 12 - Turn-Off SOA

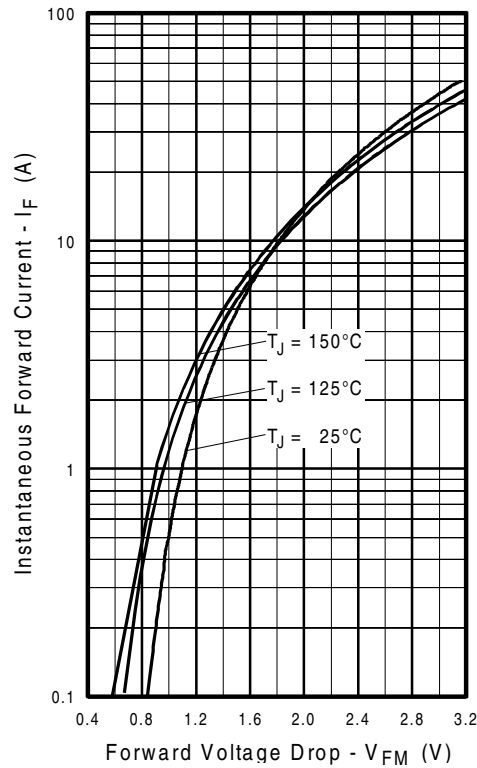

Fig. 13 - Maximum Forward Voltage Drop vs. Instantaneous Forward Current

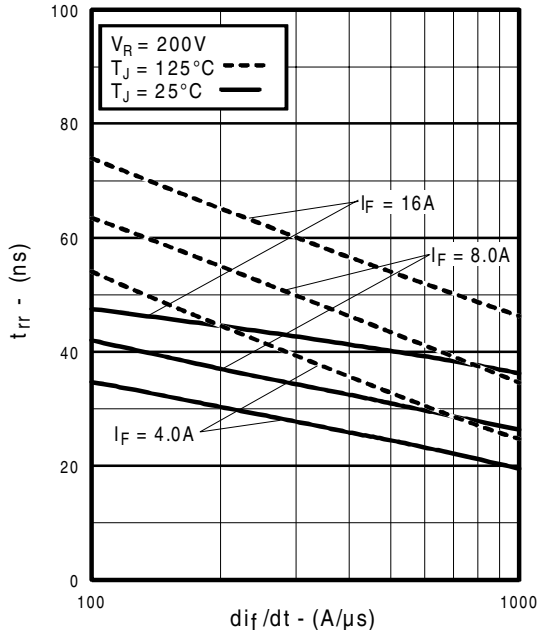

Fig. 14 - Typical Reverse Recovery vs. di_f/dt

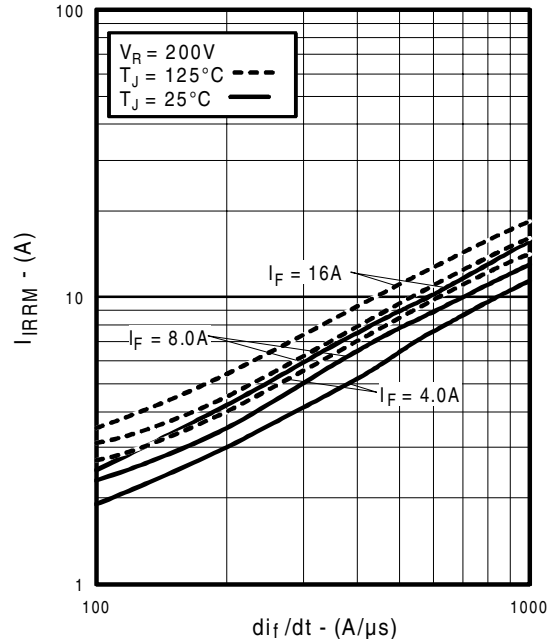

Fig. 15 - Typical Recovery Current vs. di_f/dt

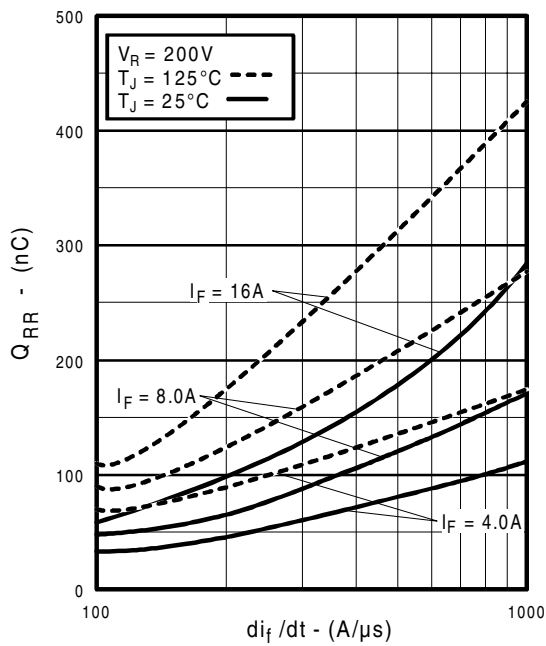

Fig. 16 - Typical Stored Charge vs. di_f/dt

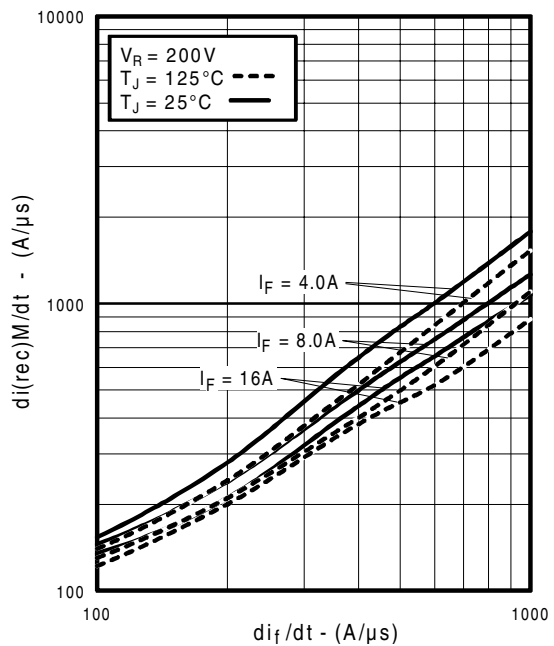

Fig. 17 - Typical $di_{(rec)M}/dt$ vs. di_f/dt

IRG4BC20FD

International
IRF Rectifier

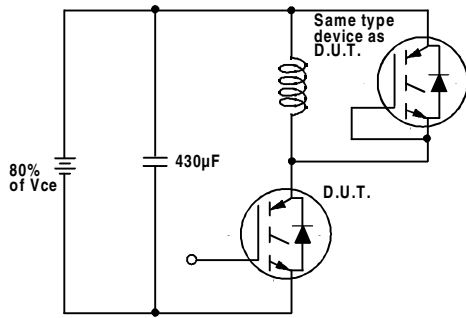

Fig. 18a - Test Circuit for Measurement of I_{LM} , E_{on} , $E_{off}(\text{diode})$, t_{rr} , Q_{rr} , I_{rr} , $t_{d(on)}$, t_r , $t_{d(off)}$, t_f

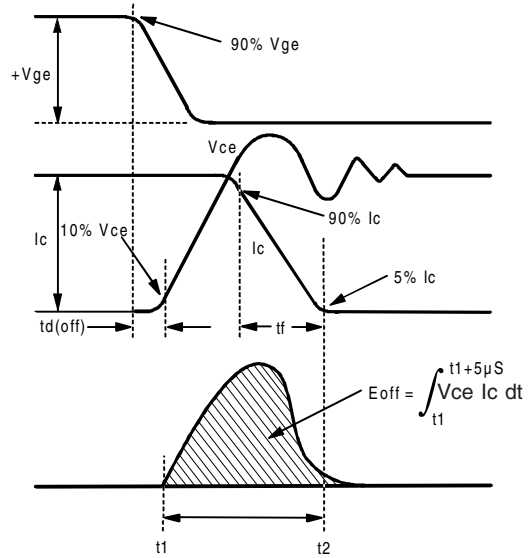

Fig. 18b - Test Waveforms for Circuit of Fig. 18a, Defining E_{off} , $t_{d(off)}$, t_f

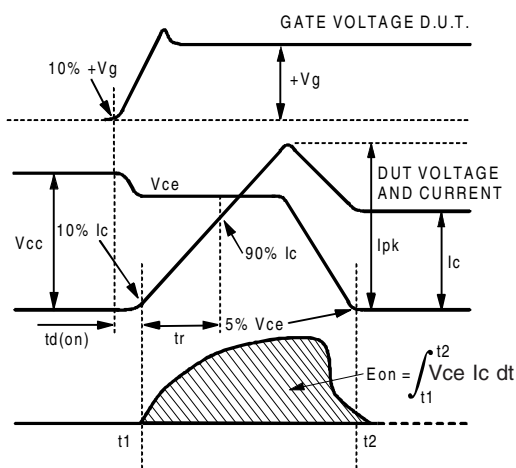

Fig. 18c - Test Waveforms for Circuit of Fig. 18a, Defining E_{on} , $t_{d(on)}$, t_r

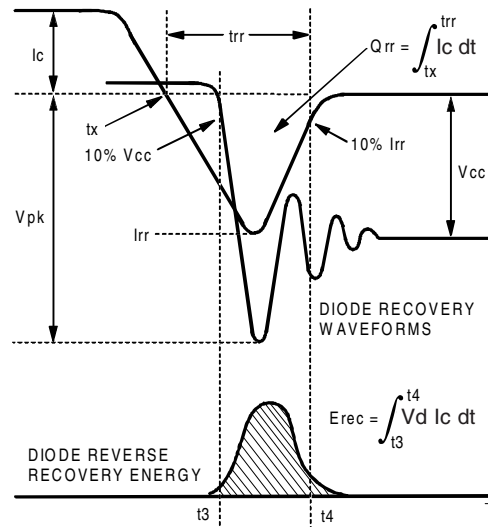

Fig. 18d - Test Waveforms for Circuit of Fig. 18a, Defining E_{rec} , t_{rr} , Q_{rr} , I_{rr}

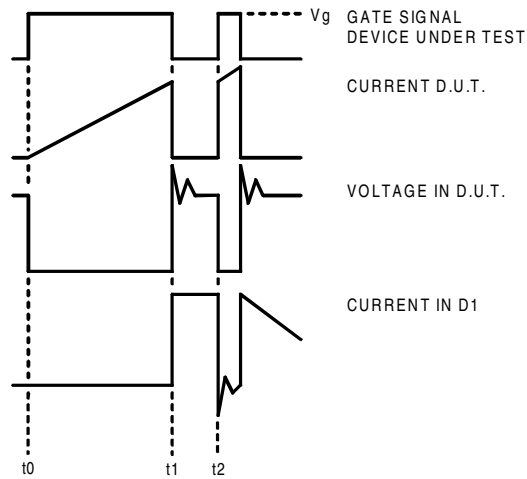

Figure 18e. Macro Waveforms for Figure 18a's Test Circuit

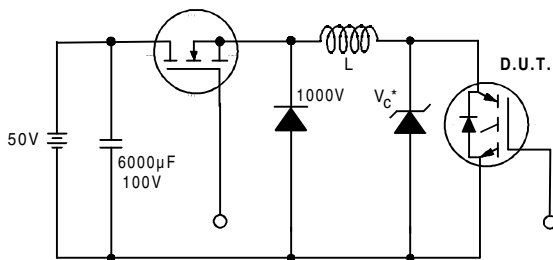

Figure 19. Clamped Inductive Load Test Circuit

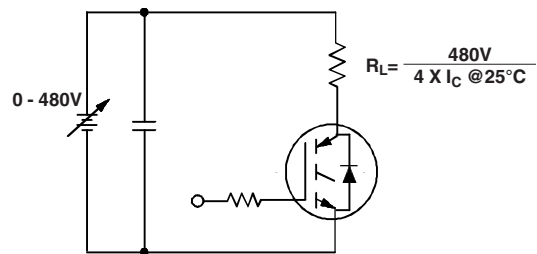

Figure 20. Pulsed Collector Current Test Circuit

IRG4BC20FD



Notes:

- ① Repetitive rating: $V_{GE}=20V$; pulse width limited by maximum junction temperature (figure 20)
- ② $V_{CC}=80\%(V_{CES})$, $V_{GE}=20V$, $L=10\mu H$, $R_G = 50\Omega$ (figure 19)
- ③ Pulse width $\leq 80\mu s$; duty factor $\leq 0.1\%$.
- ④ Pulse width $5.0\mu s$, single shot.

Case Outline — TO-220AB

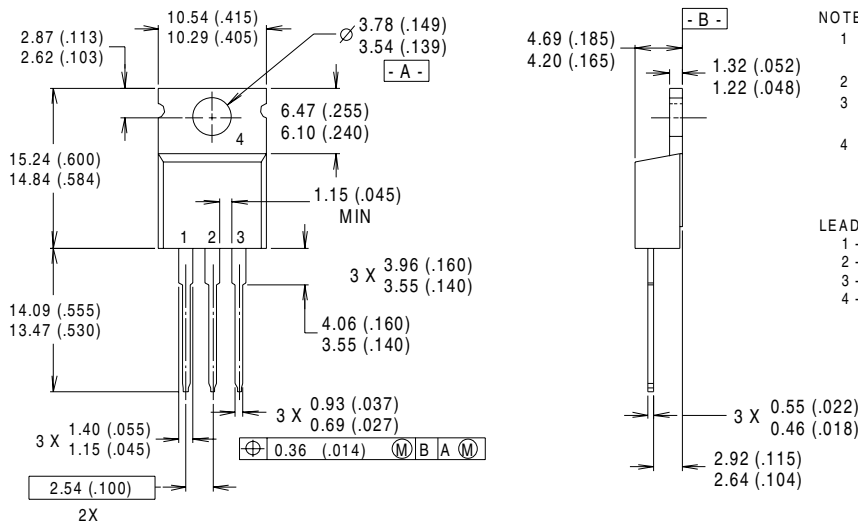

NOTES:
 1 DIMENSIONS & TOLERANCING PER ANSI Y14.5M, 1982.
 2 CONTROLLING DIMENSION : INCH.
 3 DIMENSIONS ARE SHOWN MILLIMETERS (INCHES).
 4 CONFORMS TO JEDEC OUTLINE TO-220AB.

LEAD ASSIGNMENTS
 1 - GATE
 2 - COLLECTOR
 3 - EMITTER
 4 - COLLECTOR

CONFORMS TO JEDEC OUTLINE TO-220AB
 Dimensions in Millimeters and (Inches)



IR WORLD HEADQUARTERS: 233 Kansas St., El Segundo, California 90245, USA Tel: (310) 252-7105
IR EUROPEAN REGIONAL CENTRE: 439/445 Godstone Rd, Whyteleafe, Surrey CR3 OBL, UK Tel: ++ 44 (0)20 8645 8000
IR CANADA: 15 Lincoln Court, Brampton, Ontario L6T3Z2, Tel: (905) 453 2200
IR GERMANY: Saalburgstrasse 157, 61350 Bad Homburg Tel: ++ 49 (0) 6172 96590
IR ITALY: Via Liguria 49, 10071 Borgaro, Torino Tel: ++ 39 011 451 0111
IR JAPAN: K&H Bldg., 2F, 30-4 Nishi-Ikebukuro 3-Chome, Toshima-Ku, Tokyo 171 Tel: 81 (0)3 3983 0086
IR SOUTHEAST ASIA: 1 Kim Seng Promenade, Great World City West Tower, 13-11, Singapore 237994 Tel: ++ 65 (0)838 4630
IR TAIWAN: 16 Fl. Suite D. 207, Sec. 2, Tun Haw South Road, Taipei, 10673 Tel: 886-(0)2 2377 9936

Data and specifications subject to change without notice. 7/00