

---

**RC snubber circuit design for TRIACs**

---

**Introduction**

When a TRIAC controls inductive loads, the mains voltage and the load current are not in phase. To limit the slope of the reapplied voltage and ensure right TRIAC turn-off, designer usually used a snubber circuit connected in parallel with the TRIAC. This circuit can also be used to improve TRIAC immunity to fast transient voltages.

The subject of this paper is, first of all, to analyze the snubber circuit functions and to propose a method for snubber circuit design in order to improve turn-off commutation.

**Contents**

<b>1</b>	<b>Snubber circuit functions and drawback</b> .....	<b>2</b>
1.1	Turn-off improvement .....	2
1.1.1	TRIAC turn-off reminder .....	2
1.1.2	Snubber circuit benefit at TRIAC turn-off .....	3
1.2	Overvoltage limitation at turn-off .....	4
1.3	Immunity to fast voltage transient improvement .....	5
1.4	Turn-on stress due to snubber circuit discharge .....	5
<b>2</b>	<b>How to design snubber circuit for turn-off improvement</b> .....	<b>7</b>
2.1	Step response of an RLC series circuit .....	7
2.2	RC snubber circuit design .....	9
2.2.1	Is the snubber circuit required? .....	9
2.2.2	Resistor and capacitor snubber circuit design .....	10
<b>3</b>	<b>Conclusion</b> .....	<b>14</b>
	<b>Appendix A RLC series circuit step response explanation</b> .....	<b>15</b>
	<b>Revision history</b> .....	<b>17</b>

# 1 Snubber circuit functions and drawback

## 1.1 Turn-off improvement

### 1.1.1 TRIAC turn-off reminder

When a TRIAC switches from on-state to off-state, the current passes through zero and the supply voltage is reapplied instantaneously across the structure. In certain conditions, the component is not able to block this voltage and then turns on spontaneously.

Indeed, a TRIAC can be compared to two Thyristors mounted in back-to-back and coupled with a single control area. To trigger the two Thyristors, the control area overlaps the two conduction areas.

During the conduction time, a certain quantity of charges is injected into the structure. These charges disappear by recombination during the current decrease and by extraction after the turn-off with the reverse recovery current (refer to [Figure 1](#)). Nonetheless, an excess of charge remains, particularly in the neighboring regions of the gate, which can induce the triggering of the other conduction area when the mains voltage is reapplied across the TRIAC (refer to [Figure 2](#)).

**Figure 1. TRIAC turn-off on inductive load - suitable turn-off**

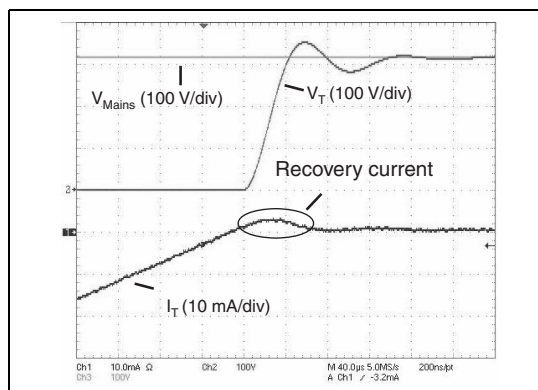

**Figure 2. TRIAC turn-off on inductive load - spurious triggering**

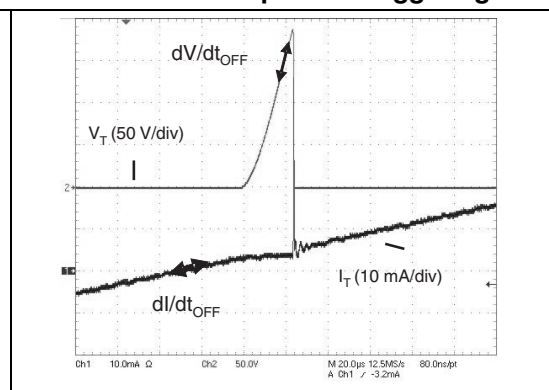

A spurious triggering depends on:

- The slope of the decreasing current, called the turn-off  $dI/dt$  or  $dI/dt_{OFF}$ . This parameter determines the quantity of charges which remains, when the current drops to zero, and which could be injected in the gate area or in the opposite Thyristor.
- The slope of the reapplied voltage, called the turn-off  $dV/dt$  or  $dV/dt_{OFF}$ . This parameter defines the capacitive current which could be injected through the gate.

### 1.1.2 Snubber circuit benefit at TRIAC turn-off

The TRIAC turn-off behavior is characterized by the datasheet curve between the critical rate of decrease of commutating on-state current ( $(di/dt)_c$ ) and the critical rate of rise of commutation off-state voltage ( $(dV/dt)_c$ ) (refer to [Figure 3](#)). These parameters are specified for the maximum operating junction temperature (worst case).

In practice, the current waveform, and thus the slope of the decreasing current, is imposed by the load. The user can then only limit the slope of the reapplied voltage. Indeed, by adding an snubber circuit across the TRIAC, the circuit time response is increased and thus,  $dV/dt_{OFF}$  is decreased (refer to [Figure 3](#)).

**Figure 3.  $(di/dt)_c$  versus  $(dV/dt)_c$  curve for Z01 standard TRIACs and snubber circuit impact**

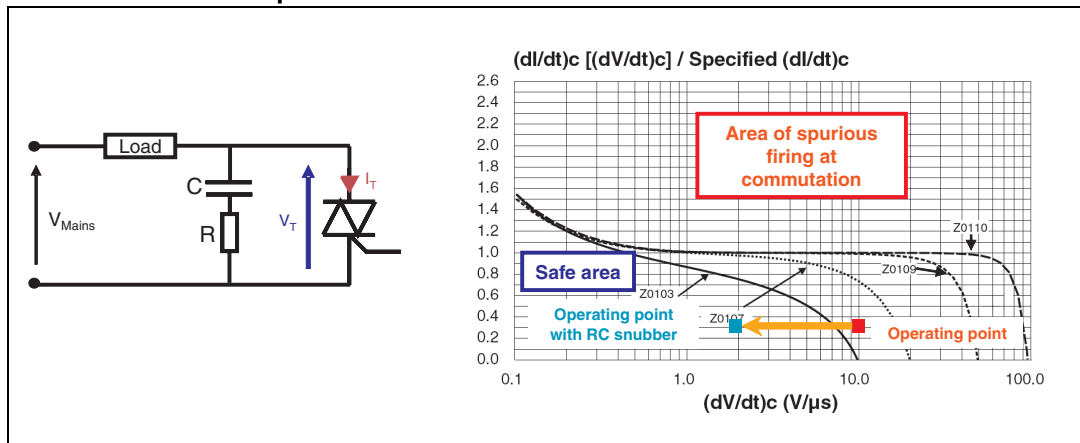

An RC snubber circuit must be used when there is a risk of TRIAC spurious triggering, i.e. when the  $di/dt_{OFF} - dV/dt_{OFF}$  couple, measured in the application, is higher than the TRIAC datasheet values,  $(di/dt)_c$  at a given  $(dV/dt)_c$ .

[Figure 4](#) shows the turn-off behavior of a Z0103 standard TRIAC which controls a 26 W drain pump. Without snubber circuit and for the maximum junction temperature ( $110^\circ\text{C}$ ), a spurious triggering appears at turn-off. Indeed, the measured  $(di/dt)_{OFF}$  and  $(dV/dt)_{OFF}$  values, equal respectively to 0.13 A/ms and 10 V/ $\mu\text{s}$ , are higher than the guarantee  $(di/dt)_c - (dV/dt)_c$  point (only 7 V/ $\mu\text{s}$  @ 0.13 A/ms, see [Figure 3](#)).

Thanks to an RC snubber circuit (10 nF and 2.7 k $\Omega$ ), the slope of the reapplied voltage can be limited to 1.5 V/ $\mu\text{s}$  and thus spurious triggering at turn-off can be avoided (see [Figure 3](#) and [Figure 4](#)).

**Figure 4. Z0103 TRIAC turn-off on inductive load without and with snubber circuit (C = 10 nF and R = 2.7 kΩ)**

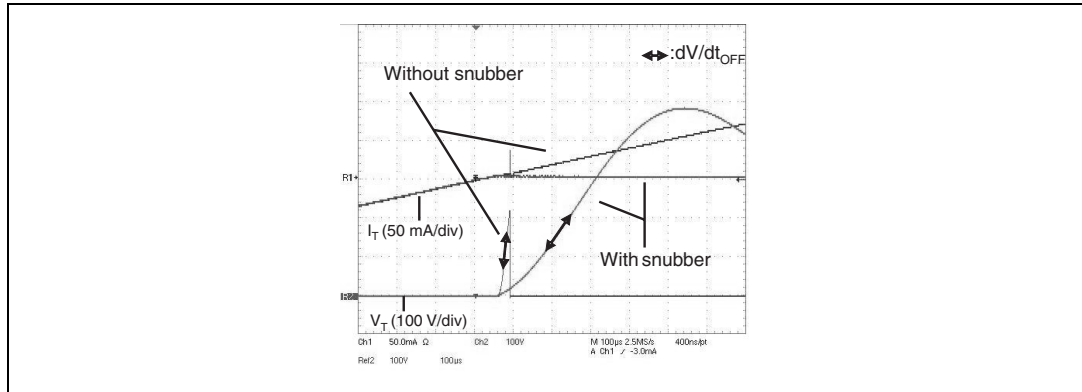

The snubber circuit design, detailed in [Section 2: How to design snubber circuit for turn-off improvement](#), is a trade-off between the maximum peak off-state voltage under pulse conditions ( $V_{DSM} / V_{RSM}$ ), the critical slope of reapplied voltage ( $(dV/dt)_c$ ) and the turn-on stress ( $dI/dt$ ). When low load inductances are controlled or, low damping factor or low slope of reapplied voltage are considered, the snubber circuit design can lead to choose a low snubber resistance value. To reduce the snubber capacitance discharge at turn-on, the resistance value is limited to a minimum value (refer to [Section 1.4](#)).

## 1.2 Overvoltage limitation at turn-off

When a TRIAC controls low root-mean-square currents inductive loads, an overvoltage could occur when the current reaches the holding current ( $I_H$ ) (refer to [Figure 5](#)).

If the maximum value of the overvoltage ( $V_M$ ) exceeds the maximum peak off-state voltage under pulse conditions ( $V_{DSM} / V_{RSM}$ ), the TRIAC may conduct without any gate current or may be even damaged. The protections against overvoltage at turn-off are:

- **A clamping strategy** - use a varistor or an ACSTM / ACST (refer to AN1172 about protected AC Switch™).
- **A damping strategy** - a snubber circuit. An RC snubber circuit limits the slope of the voltage rise and could maintain the overvoltage at a lower value than the maximum allowed value.

**Figure 5. Overvoltage at TRIAC turn-off with and without snubber circuit (C = 10 nF and R = 2.7 kΩ)**

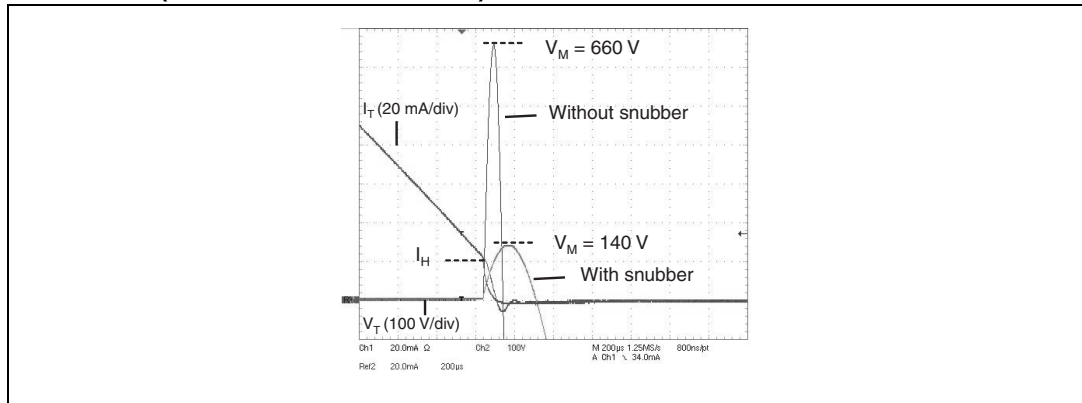

### 1.3 Immunity to fast voltage transient improvement

Electrical noise may appear on the mains and generates across the TRIAC fast voltage variations, as described in IEC 61000-4-4 standard.

Fast voltage variations can create a gate current ( $I_G$ ), due to the junction capacitance between A2 and the gate, and could trigger the TRIAC. The maximum rate of rise of off-state voltage that a TRIAC is able to withstand without turning on is called the static  $dV/dt$ . A spurious triggering due to static  $dV/dt$  is not dangerous for a component. The aim of the snubber circuit is to reduce the static  $dV/dt$  at a lower level than the  $dV/dt$  specified in the datasheet to avoid spurious triggering.

An RC snubber circuit improves the TRIAC immunity against fast voltage transients. For example, regarding to the standard IEC 61000-4-4, a Z0109 standard TRIAC has a typical immunity level of about 0.7 kV, without any snubber circuit. With a snubber circuit (1 nF and 47  $\Omega$ ), the Z0109 immunity level can reach 4.0 kV.

Designers must manage the following trade-off to choose the suitable RC snubber circuit:

- Reduce  $dV/dt$  rates: the snubber capacitance must be high and the snubber resistance must be low;
- Reduce  $dI/dt$  rate at turn-on (refer to [Section 1.4](#)): the snubber capacitance must be low and the snubber resistance must be high.

### 1.4 Turn-on stress due to snubber circuit discharge

The snubber circuit design can lead to low resistance value. However, the snubber resistor reduces the rate of current rise at turn-on ( $dI/dt_{ON}$ ) during the capacitor discharge. An higher  $dI/dt_{ON}$  than the  $dI/dt$  specified in the datasheet may damage the TRIAC.

The rate of current rise is directly proportional to the initial capacitance voltage and inversely proportional to the series inductances of the board and the snubber resistor. The rate of current rise depends also on the turn-on speed of the TRIAC, the triggering quadrants and the gate current amplitude. So, there is no simple way to predict the rate of current rise.

Usually, the inductance of the circuit layout is very low, in the range of few nH. Indeed, to optimize the snubber circuit efficiency, the snubber circuit must be located very close to the TRIAC (tracks length lower than 2 cm).

From datasheet specifications, there are three ranges of maximum  $dI/dt$ :

- $dI/dt = 20 \text{ A}/\mu\text{s}$ : for low current rating of TRIACs (0.8 A and 1 A).
- $dI/dt = 50 \text{ A}/\mu\text{s}$ : for the other TRIACs (4 A up to 40 A).
- $dI/dt = 100 \text{ A}/\mu\text{s}$ : for some ACSTs (6 A up to 12 A).

To keep the  $dI/dt_{ON}$  below 50  $\text{A}/\mu\text{s}$  for TRIACs and below 100  $\text{A}/\mu\text{s}$  for ACSTs, the snubber resistance must be typically higher than 47  $\Omega$  (refer to [Figure 6](#)). For a 20  $\text{A}/\mu\text{s}$  maximum  $dI/dt$ , the minimum resistance value is about 620  $\Omega$ . Therefore, depending on the component used, some tests should be performed to define accurately the minimum resistance value.

Figure 6. Typical snubber circuit discharge ( $C = 10 \text{ nF}$  and  $R = 47 \text{ }\Omega$ ) with BTA/BTB16 TRIAC at peak mains voltage (quadrant 3,  $I_G = 2 \times I_{GT}$ )

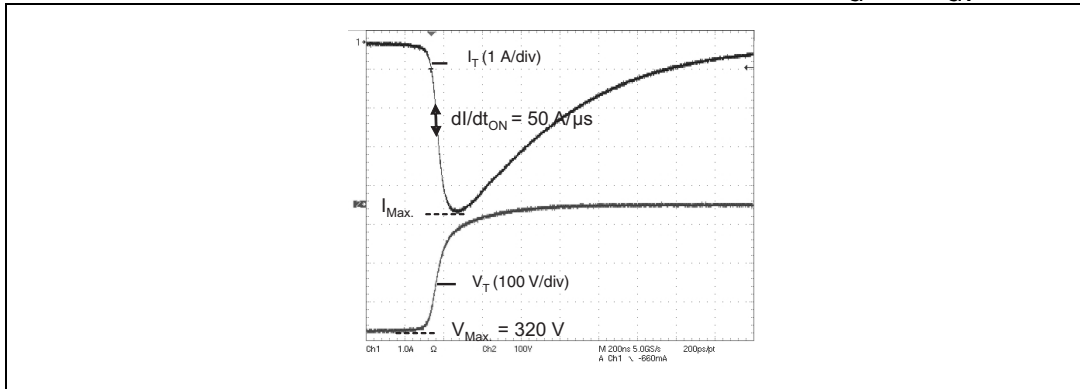

## 2 How to design snubber circuit for turn-off improvement

### 2.1 Step response of an RLC series circuit

The  $R_S C_S$  snubber circuit makes up a resonant circuit with an inductive load (refer L and R on [Figure 7](#)). At turn-off, the snubber circuit limits the slope of the reapplied voltage ( $dV/dt_{OFF}$ ) but generates an overvoltage ( $V_P$ ). The snubber circuit design results in a trade-off to respect both the reapplied voltage slope ( $(dV/dt)_c$ ) and the maximum peak off-state voltage under pulse conditions ( $V_{DSM} / V_{RSM}$ ).

The electrical circuit analyzed in this paragraph is given by [Figure 7](#).

**Figure 7. Application circuit and its equivalent diagram at turn-off**

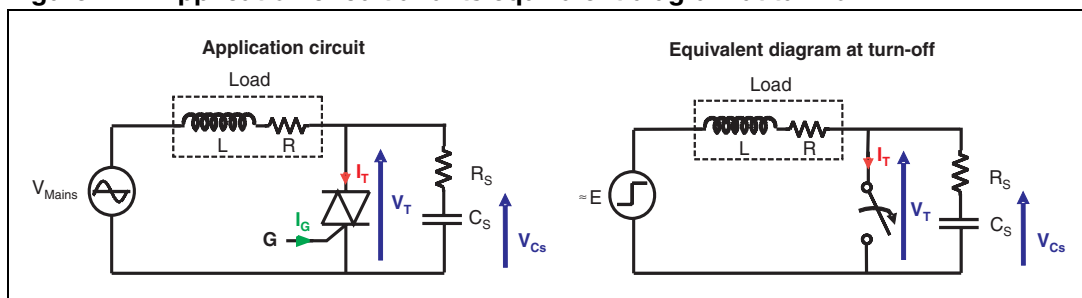

For a second order linear differential equation with a step function input, the voltage variation across the snubber capacitance ( $V_{C_S}(t)$ ) and the TRIAC ( $V_T(t)$ ) is given by:

#### Equation 1

$$\frac{1}{\omega_0^2} \cdot \frac{d^2 V_{C_S}(t)}{dt^2} + \frac{2 \cdot \xi}{\omega_0} \cdot \frac{dV_{C_S}(t)}{dt} + V_{C_S}(t) = E$$

#### Equation 2

$$V_T(t) = R_S \cdot C_S \cdot \frac{dV_{C_S}(t)}{dt} + V_{C_S}(t)$$

With damping factor:

#### Equation 3

$$\xi = \frac{(R_S + R)_{(\Omega)}}{2} \cdot \sqrt{\frac{C_{S(F)}}{L_{(H)}}}$$

Undamped natural resonance:

#### Equation 4

$$\omega_{0(\text{rad/s})} = \frac{1}{\sqrt{L_{(H)} \cdot C_{S(F)}}}$$

Final voltage value:

**Equation 5**

$$E = \sqrt{2} \cdot V_{RMS} \cdot \sin(\varphi) \text{ with } \sin(\varphi) = \frac{L \cdot \omega}{\sqrt{R^2 + (L \cdot \omega)^2}}$$

$V_{RMS}$ : mains rms voltage

Snubber circuit divider ratio:

**Equation 6**

$$M = \frac{R_s}{R_s + R}$$

By solving the second order linear differential equation according to the damping factor and initial conditions (refer to [Appendix A: RLC series circuit step response explanation](#)), two diagrams can be defined. These diagrams give the slope of the voltage rise ( $dV/dt_{OFF}$ ) and the peak voltage ( $V_P$ ) according to the damping factor ( $\xi$ ) and the load resistance ( $M$ ) (refer to [Figure 8](#)).

The voltage rise slope ( $dV/dt_{OFF}$ ) is defined as the maximum instantaneous voltage rise slope.

**Figure 8. Trade-off between normalized peak voltage ( $Z = V_P/E$ ), normalized voltage rise slope ( $K = dV/dt_{OFF}/(E \times \omega_0)$ ) according to damping factor ( $\xi$ ) and the divider ratio ( $M$ )**

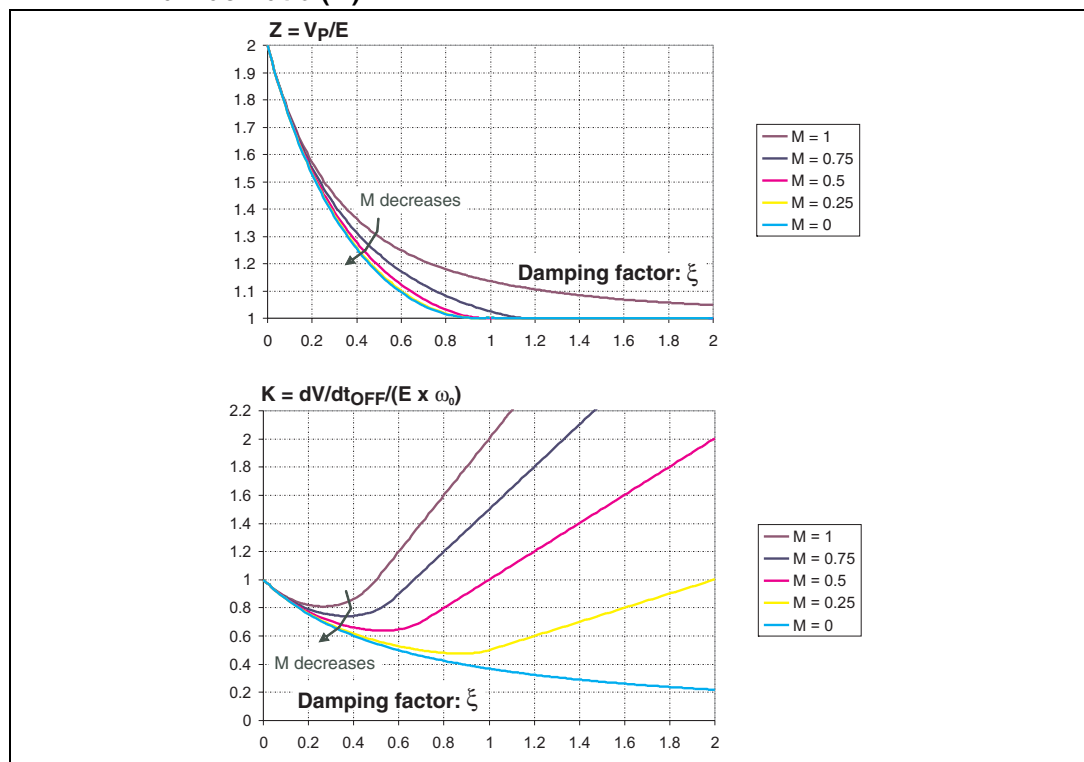

As shown on these two diagrams, the load resistance ( $R$ ) helps to reduce  $dV/dt_{OFF}$  and  $V_P$ . The load impact is significant if the damping factor is higher than 0.2.



## 2.2 RC snubber circuit design

### 2.2.1 Is the snubber circuit required?

Without snubber circuit, the slope of reapplied voltage is limited by the TRIAC capacitance between anode and cathode junction. The oscillating circuit is constituted by the load, L and R, and the internal capacitance,  $C_T$ , of the TRIAC.

For example, the typical internal capacitances of 1 A, 12 A and 24 A TRIACs are respectively 12 pF, 90 pF and 180 pF (without direct voltage junction polarisation, worst case). Without snubber circuit and for most part of inductive loads, the damping factor ( $\xi$ ) is generally lower than 1.

For an underdamped oscillating circuit ( $0 \leq \xi < 1$ ), the voltage variation across the TRIAC ( $V_T(t)$ ) is:

#### Equation 7

$$V_T(t) = E \cdot e^{-\xi \omega_0 t} \left( \cos(\omega_p \cdot t) + \frac{\xi \omega_0}{\omega_p} \cdot \sin(\omega_p \cdot t) \right)$$

With damped natural resonance:

#### Equation 8

$$\omega_p = \omega_0 \cdot \sqrt{1 - \xi^2}$$

For example, in the case of a 26 W drain pump ( $L = 2.4$  H and  $R = 190 \Omega$  at 50 Hz) controlled by a Z0103 TRIAC ( $C_T = 12$  pF), the damping factor is close to zero ( $\xi = 2.1 \times 10^{-4}$ ).

For low damping factor, the normalized voltage rise slope K is equal to 1 (refer to [Figure 8](#), lower graph). The maximum slope of reapplied voltage across the TRIAC is then:

#### Equation 9

$$dV / dt_{OFF} (V / \mu s) = \frac{\sqrt{2} \cdot V_{RMS(V)} \cdot \sin(\varphi)}{\sqrt{L_{(H)} \cdot C_{T(F)}}} \cdot 10^{-6}$$

According to this formula, the estimated  $dV/dt_{OFF}$  is equal to 59 V/ $\mu$ s without snubber circuit. As shown in [Figure 9](#), the measured  $dV/dt_{OFF}$  is in fact about 10 V/ $\mu$ s.

The error between the [Equation 9](#) result and real value is due to the fact that we didn't take into account the load inductance saturation (real value is higher at low current), the parallel parasitic capacitor of the load, the recovery current and the load resistance increase with frequency. Moreover, the turn-off measurement is done with a voltage probe which adds a 12 pF capacitor across the TRIAC. So, the measured  $dV/dt_{OFF}$  is always lower than the theoretical value, given by [Equation 9](#).

**Figure 9. Z0103 TRIAC turn-off on inductive load (26 W drain pump) without snubber circuit and in transient operating**

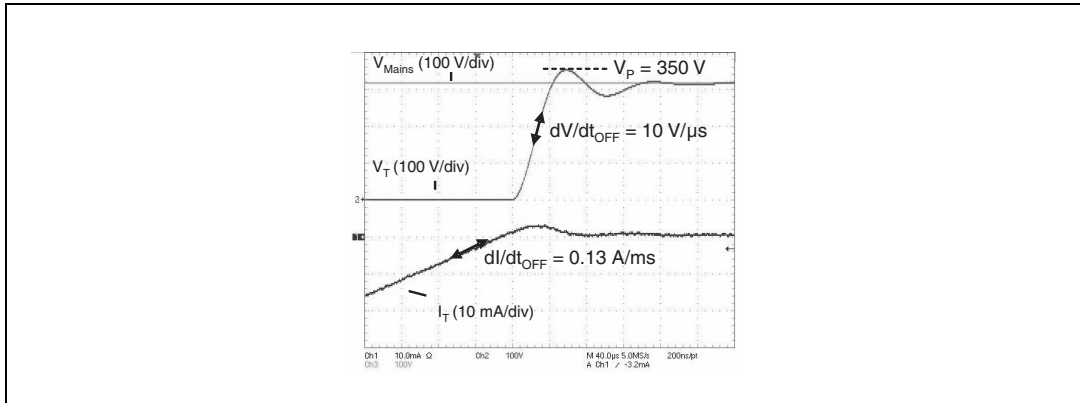

An RC snubber circuit must be used when there is a risk of TRIAC spurious triggering, i.e. when the measured  $dI/dt_{OFF}$  and  $dV/dt_{OFF}$  values are higher than the specified  $(dI/dt)_c$  and  $(dV/dt)_c$  values.

In our application case and for the worst case load conditions (transient operating), the measured  $(dI/dt)_{OFF}$  and  $(dV/dt)_{OFF}$  values are equal respectively to 0.13 A/ms and 10 V/μs. These values are higher than the specified  $(dI/dt)_c$  and  $(dV/dt)_c$  values, see [Section 1.1.2](#).

Thanks to an RC snubber circuit, rated in the next paragraph, the slope of the reapplied voltage could be limited and thus spurious triggering at turn-off could be avoided.

### 2.2.2 Resistor and capacitor snubber circuit design

The snubber circuit design depends on the damping factor ( $\xi$ ).

When  $\xi$  decreases, the snubber resistor and capacitor values decrease but the peak voltage and snubber circuit discharge current increase. Maximum instantaneous  $dV/dt_{OFF}$  occurs at a time later than  $t = 0$  when  $\xi$  is lower than 0.5.

When  $\xi$  increases, the snubber resistor and capacitor values increase and the voltage overshoot decreases. The maximum instantaneous  $dV/dt_{OFF}$  occurs at  $t = 0$  when  $\xi$  is higher than 0.5.

Low damping factors are recommended. Indeed, thanks to the high voltage capability of TRIACs, the snubber circuit can be optimized to reduce the capacitor value and, in the same way, reduce the snubber circuit cost.

To illustrate the RC snubber circuit design, a 26 W drain pump ( $L = 2.4$  H and  $R = 190 \Omega$  at 50 Hz) controlled by a Z0103 TRIAC is considered.

Two methods can be used to design the snubber circuit. The first method designs the RC snubber circuit with load resistance consideration. The second method considers pure inductive load.

The first method of RC snubber circuit design is divided in four steps:

#### 1. Snubber resistance choice

To limit the TRIAC turn-on stress and optimize the TRIAC immunity against fast voltage transients, the snubber resistance is fixed to the minimum value.

For Z01 TRIAC, the  $dI/dt$  at turn-on is limited to 20 A/μs. The minimum snubber resistance value is 620  $\Omega$  (refer to [Section 1.4](#)).

Using [Equation 6](#), the snubber circuit divider ratio M is equal to:

$$M = 0.77 \text{ with } R = 190 \, \Omega \text{ and } R_S = 620 \, \Omega$$

## 2. Damping factor definition

The snubber capacitor depends on the undamped natural resonance ( $\omega_0$ ) and the damping factor ( $\xi$ ). Consider the following modified forms of [Equation 4](#) and [Equation 3](#):

### Equation 4 modified

$$C_S = \frac{1}{\omega_0^2 \cdot L} \text{ with } \omega_0 = \frac{dV / dt_{OFF}}{E \cdot K}$$

Where K is the normalized voltage rise slope (refer to the lower graphic in [Figure 8](#)).

### Equation 3 modified

$$C_S = 4 \cdot \frac{L}{(R + R_S)^2} \cdot \xi^2$$

From the two previous equations, the ratio between the normalized voltage rise slope (K) and the damping factor ( $\xi$ ) is given by [Equation 10](#). [Figure 10](#), derived from the lower graph in [Figure 8](#) gives the variation of this ratio with  $\xi$ :

### Equation 10

$$\frac{K}{\xi} = 2 \cdot \frac{L}{R_S + R} \cdot \frac{dV / dt_{OFF}}{E}$$

For the drain pump controlled ( $L = 2.4 \text{ H}$  and  $R = 190 \, \Omega$  at  $50 \text{ Hz}$ ) and by using [Equation 5](#), the final voltage value E is:

$$E = 306 \text{ V for } V_{RMS} = 230 \text{ V and with } \varphi \approx 76^\circ$$

To avoid spurious triggering with Z0103 TRIAC, the  $dV/dt_{OFF}$  is fixed to  $2 \text{ V}/\mu\text{s}$  (lower than maximum allowed  $(dV/dt)_c$ , see [Figure 2](#)).

Thus according to [Equation 10](#), the ratio between the normalized voltage rise slope and the damping factor is equal to 38. [Figure 10](#) gives then the damping factor value ( $\xi = 0.026$ ).

**Figure 10. Ratio between normalized voltage rise slope ( $K = dV/dt_{OFF} / (E \times \omega_0)$ ) and damping factor ( $\xi$ ) according to the damping factor ( $\xi$ )**

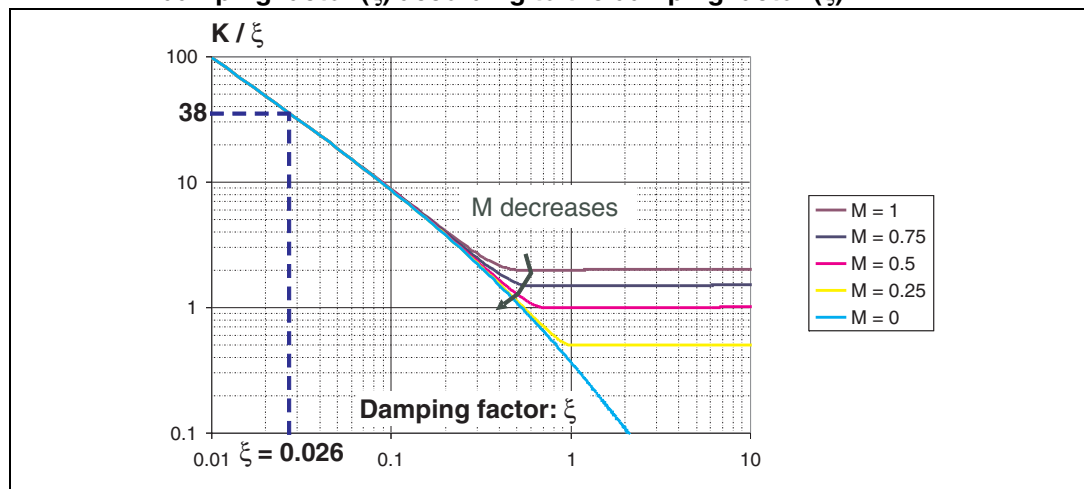

3. Snubber capacitance and overvoltage calculations

The snubber capacitance is given by the modified form of *Equation 3*:

$$C_{S(nF)} = 4 \cdot \frac{L}{(R + R_S)^2} \cdot \xi^2 \cdot 10^9 \approx 9.9 \text{ nF with } \xi = 0.026$$

The peak voltage is given in the upper graphic of *Figure 8*. A component with a 600 V capability will be suitable.

$$V_P = 1.92 \cdot E \approx 607 \text{ V with } \xi = 0.026.$$

4. RC snubber circuit validation

The turn-off and turn-on behaviors must be checked experimentally to validate the designed RC snubber circuit.

For turn-off commutation, the measured slope of the voltage rise is 1.7 V/μs (*Figure 10*) and is very close to the theoretical slope (2 V/μs). The measured peak voltage (520 V) is lower than the calculated value (607 V) due to the RLC model approximations (refer to *Section 2.2.1*).

**Figure 11. Z0103 TRIAC turn-off on inductive load with snubber circuit (C = 10 nF and R = 620 Ω)**

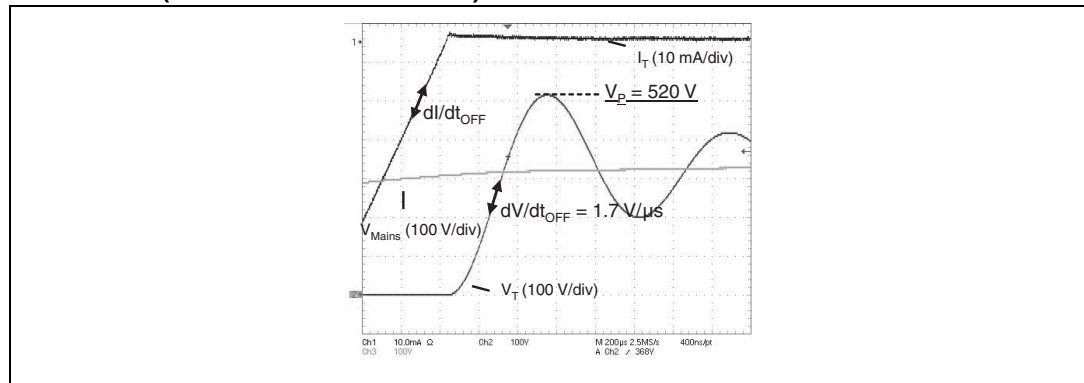

The second method of RC snubber circuit design allows a quicker snubber capacitor choice. The capacitor is directly chosen from the load rms current (refer to *Figure 12*). Pure inductive loads are considered and the slope of the reapplied voltage is fixed to 2 V/μs.

For a given rms load current and according to the snubber resistance used (47 Ω or 620 Ω), the ratio between the normalized voltage rise slope ( $K = dV/dt_{OFF} / (E \cdot \omega_0)$ ) and damping factor ( $\xi$ ) is defined (refer to *Equation 11*). Then, as in the first snubber design method, the damping factor is given by *Figure 10*, the capacitor value by *Equation 3 modified* and the peak voltage by the upper graph of *Figure 8*.

**Equation 11**

$$\frac{K}{\xi} = 2 \cdot \frac{L}{R_S + R} \cdot \frac{dV / dt_{OFF}}{E} \quad \text{with } L = \frac{V_{RMS}}{I_{RMS} \cdot 2 \cdot \pi \cdot f}$$

**Figure 12. Snubber capacitor value and normalized peak voltage (Z = V<sub>p</sub>/E) according to the rms load current (assumptions: (dV/dt)<sub>OFF</sub> = 2.0 V/μs and pure inductive load (worst case))**

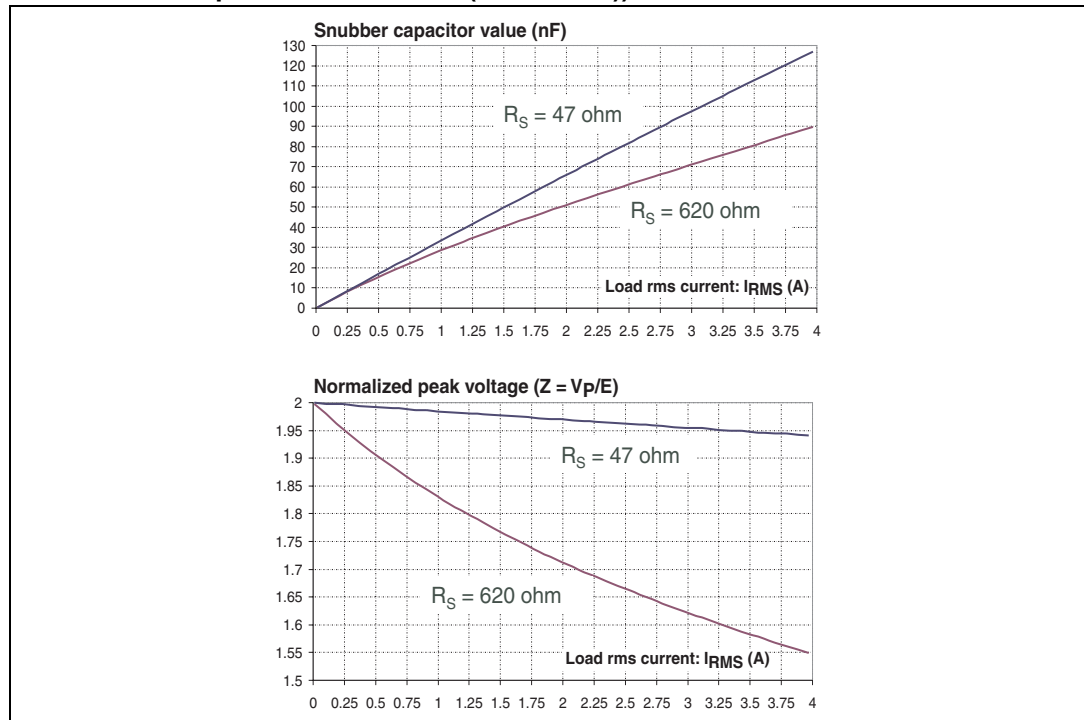

*Note:* For inductive load with rms current higher than 4 A, Snubberless TRIACs are recommended.

In the case of a 26 W drain pump, the rms load current is 0.3 A in transient operating (worst case). The corresponding snubber capacitor value is about 10 nF, like defined previously. The estimated peak voltage is 613 V. The estimated peak voltage is 20% higher than the measured value due to the RLC model approximations (refer to [Section 2.2.1](#)) and because, in the application, the load is not purely inductive and the peak voltage is limited by the load resistance.

### 3 Conclusion

An RC snubber circuit is often used with TRIACs and presents different functions:

- Aid circuit for turn-off commutation
- Fast transient voltage suppressor
- Overvoltage limiter at turn-off commutation in case of inductive load with low rms current

The RC snubber circuit drawback is the turn-on stress induced by the capacitor discharge.

Thanks to the high voltage capability of TRIACs, the snubber circuit design can be optimized in order to reduce the capacitor value and, in the same way, reduce the snubber circuit cost.

Nevertheless, when low load inductances are controlled or, low damping factor or low slope of reapplied voltage are considered, the snubber circuit design can lead to choose a low snubber resistance value. To limit the snubber capacitor discharge through the TRIAC at turn-on, the resistor value must be higher than a minimum value (typically 47  $\Omega$  for most TRIACs and ACSTs).

## Appendix A RLC series circuit step response explanation

The  $R_S C_S$  snubber circuit and the load, L and R, make up a resonant circuit.

The electrical circuit analyzed in this Appendix is shown in [Figure 13](#)

**Figure 13. Application circuit and its equivalent diagram at turn-off commutation**

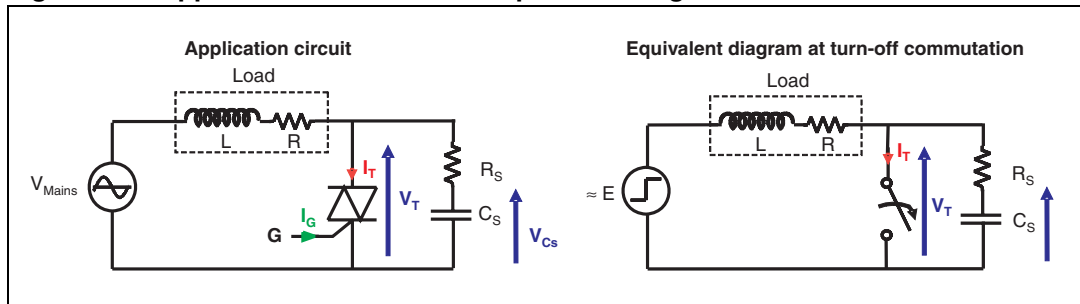

*Note:* In this Appendix the equations 1 to 6 are reproduced here with the same numbering to facilitate use of this application note.

For a second order linear differential equation with a step function input, the voltage variation across the snubber capacitance ( $V_{C_S}(t)$ ) and the TRIAC ( $V_T(t)$ ) is given by:

### Equation 1

$$\frac{1}{\omega_0^2} \cdot \frac{d^2 V_{C_S}(t)}{dt^2} + \frac{2 \cdot \xi}{\omega_0} \cdot \frac{dV_{C_S}(t)}{dt} + V_{C_S}(t) = E$$

### Equation 2

$$V_T(t) = R_S \cdot C_S \cdot \frac{dV_{C_S}(t)}{dt} + V_{C_S}(t)$$

With damping factor:

### Equation 3

$$\xi = \frac{(R_S + R)_{(\Omega)}}{2} \cdot \sqrt{\frac{C_{S(F)}}{L_{(H)}}}$$

Undamped natural resonance:

### Equation 4

$$\omega_{0(\text{rad/s})} = \frac{1}{\sqrt{L_{(H)} \cdot C_{S(F)}}}$$

Final voltage value:

**Equation 5**

$$E = \sqrt{2} \cdot V_{RMS} \cdot \sin(\varphi) \text{ with } \sin(\varphi) = \frac{L \cdot \omega}{\sqrt{R^2 + (L \cdot \omega)^2}}$$

$V_{RMS}$ : mains rms voltage

Snubber circuit divider ratio:

**Equation 6**

$$M = \frac{R_s}{R_s + R}$$

The voltage variation ( $V_T(t)$ ) across the TRIAC depends on the damping factor coefficient. For each damping factor, the initial conditions to solve the differential equation are the same:

At  $t = 0$

**Equation 12**

$$\left( \frac{dV_T}{dt} \right)_0 = \frac{E \cdot R_s}{L}$$

At  $t = \infty$

**Equation 13**

$$V_T(\infty) = E$$

*Note:* The recovery current due to the storage charge is not considered in the initial conditions.

- Underdamped oscillating circuit:  $0 \leq \xi \leq 1$

**Equation 14**

$$V_T(t) = E - E \cdot \left( \cos(\omega_p \cdot t) + (2 \cdot (1 - M) - 1) \cdot \frac{\xi \cdot \omega_0}{\omega_p} \cdot \sin(\omega_p \cdot t) \right) \cdot e^{-\xi \cdot \omega_0 \cdot t}$$

With damped natural resonance

**Equation 15**

$$\omega_p = \omega_0 \cdot \sqrt{1 - \xi^2}$$

- Damped oscillating circuit:  $\xi = 1$

**Equation 16**

$$V_T(t) = E - E \cdot (1 + (2 \cdot (1 - M) - 1) \cdot \omega_0 \cdot t) \cdot e^{-\omega_0 \cdot t}$$

With damped natural resonance

**Equation 17**

$$\omega_p = \omega_0$$



- Overdamped oscillating circuit:  $\xi > 1$

**Equation 18**

$$V_T(t) = E - E \left( \cosh(\omega_p \cdot t) + (2 \cdot (1 - M) - 1) \cdot \frac{\xi \cdot \omega_0}{\omega_p} \cdot \sinh(\omega_p \cdot t) \right) \cdot e^{-\xi \cdot \omega_0 \cdot t}$$

With damped natural resonance

**Equation 19**

$$\omega_p = \omega_0 \cdot \sqrt{\xi^2 - 1}$$

Thanks to these three equations and their derivatives, the variation between the peak voltage and the slope of the voltage rise can be defined according to the damping factor and the resistive load.

The damping factor determines the shape of the voltage wave (refer to [Figure 14](#)).

**Figure 14. Voltage waves ( $V_T(t)$ ) for different damping factors ( $\xi$ ) (assumption  $M = 1$ )**

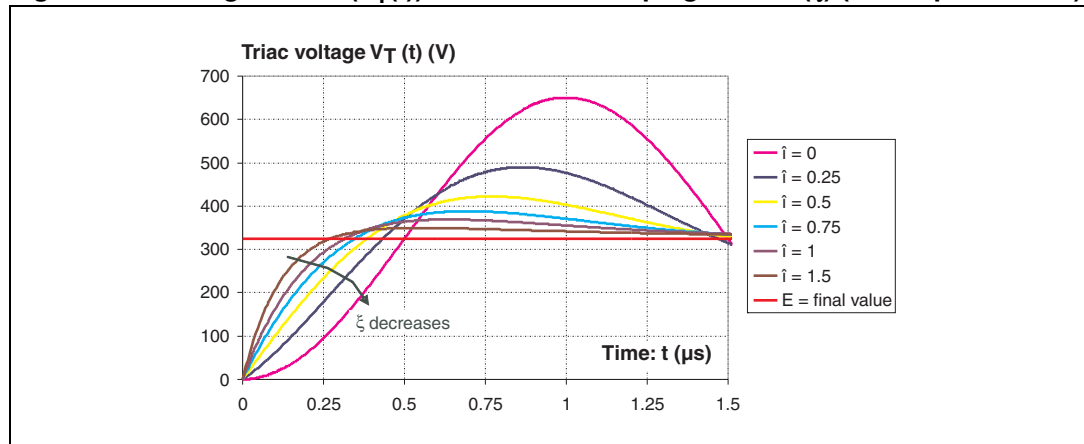

When  $\xi$  is lower than 0.5, the voltage shape is not exponential and the maximum instantaneous slope of voltage rise occurs at a time later than  $t = 0$ .

When  $\xi$  is equal and higher than 1, some overshoots occur even if the oscillating circuit is damped and overdamped.

## Revision history

**Table 1. Document revision history**

Date	Revision	Changes
1995	1	Initial release.
22-Oct-2007	2	Reformatted to current standards. Complete rewrite for text and graphics. Part numbers updated for current products.

**Please Read Carefully:**

Information in this document is provided solely in connection with ST products. STMicroelectronics NV and its subsidiaries ("ST") reserve the right to make changes, corrections, modifications or improvements, to this document, and the products and services described herein at any time, without notice.

All ST products are sold pursuant to ST's terms and conditions of sale.

Purchasers are solely responsible for the choice, selection and use of the ST products and services described herein, and ST assumes no liability whatsoever relating to the choice, selection or use of the ST products and services described herein.

No license, express or implied, by estoppel or otherwise, to any intellectual property rights is granted under this document. If any part of this document refers to any third party products or services it shall not be deemed a license grant by ST for the use of such third party products or services, or any intellectual property contained therein or considered as a warranty covering the use in any manner whatsoever of such third party products or services or any intellectual property contained therein.

**UNLESS OTHERWISE SET FORTH IN ST'S TERMS AND CONDITIONS OF SALE ST DISCLAIMS ANY EXPRESS OR IMPLIED WARRANTY WITH RESPECT TO THE USE AND/OR SALE OF ST PRODUCTS INCLUDING WITHOUT LIMITATION IMPLIED WARRANTIES OF MERCHANTABILITY, FITNESS FOR A PARTICULAR PURPOSE (AND THEIR EQUIVALENTS UNDER THE LAWS OF ANY JURISDICTION), OR INFRINGEMENT OF ANY PATENT, COPYRIGHT OR OTHER INTELLECTUAL PROPERTY RIGHT.**

**UNLESS EXPRESSLY APPROVED IN WRITING BY AN AUTHORIZED ST REPRESENTATIVE, ST PRODUCTS ARE NOT RECOMMENDED, AUTHORIZED OR WARRANTED FOR USE IN MILITARY, AIR CRAFT, SPACE, LIFE SAVING, OR LIFE SUSTAINING APPLICATIONS, NOR IN PRODUCTS OR SYSTEMS WHERE FAILURE OR MALFUNCTION MAY RESULT IN PERSONAL INJURY, DEATH, OR SEVERE PROPERTY OR ENVIRONMENTAL DAMAGE. ST PRODUCTS WHICH ARE NOT SPECIFIED AS "AUTOMOTIVE GRADE" MAY ONLY BE USED IN AUTOMOTIVE APPLICATIONS AT USER'S OWN RISK.**

Resale of ST products with provisions different from the statements and/or technical features set forth in this document shall immediately void any warranty granted by ST for the ST product or service described herein and shall not create or extend in any manner whatsoever, any liability of ST.

ST and the ST logo are trademarks or registered trademarks of ST in various countries.

Information in this document supersedes and replaces all information previously supplied.

The ST logo is a registered trademark of STMicroelectronics. All other names are the property of their respective owners.

© 2007 STMicroelectronics - All rights reserved

STMicroelectronics group of companies

Australia - Belgium - Brazil - Canada - China - Czech Republic - Finland - France - Germany - Hong Kong - India - Israel - Italy - Japan - Malaysia - Malta - Morocco - Singapore - Spain - Sweden - Switzerland - United Kingdom - United States of America

[www.st.com](http://www.st.com)