

Ground loop problems and how to get rid of them

Written and copyright by Tomi Engdahl 1997-2000

NOTE: The information presented here is believed to be correct and is made available here by the author. The author of this document is not liable for any effect this information or any use thereof may have.

The documents have been used and recommended by many people and are believed to be accurate. So accurate that they have also been featured as [GB AUDIO Ground loops DATA SHEET](#) on their web pages (with permission from me).

Basics

A good power distribution system is essential for proper operation of audio system. Professional audio systems just doesn't work well with normal extension cords running hundreds of feet to a stage. Besides the power feed the good grounding of the whole system is essential.

Ground loop is a condition where an unintended connection to ground is made through an interfering electrical conductor. Generally ground loop connection exists when an electrical system is connected through more than one way to the electrical ground.

When two or more devices are connected to a common ground through different paths, a ground loop occurs. Currents flow through these multiple paths and develop voltages which can cause damage, noise or 50Hz/60Hz hum in audio or video equipment. To prevent ground loops, all signal grounds need to go to one common point and when two grounding points cannot be avoided, one side must isolate the signal and grounds from the other.

Usually ground loops are an after-the-fact type of problem in which the end-user blames the installer, the installer blames the manufacturer, and actually nobody is at fault. Neither the manufacturer nor the installer can usually predict where a loop will occur. Only after the system is installed can it be determined if a problem will exist.

Ground loop problems can be corrected and avoided. It is important for the dealer, installer and the end user to be aware that this problem can occur. It is a good idea to design the system to avoid most obvious source of this kind of problems, and then be prepared still to face some problems when starting to use the system. A ground loop problem may occur at several points in the system, and each occurrence of the problem must be corrected individually.

Why grounding is so important ?

Earthing of electrical systems is required for a number of reasons, principally to ensure the safety of people near the system and to prevent damage to the system itself in the event of a fault. The function of the protective conductor, or earth, is to provide a low resistance path for fault current so that the circuit protective devices operate rapidly to disconnect the supply.

The NEC, National Electrical Code defines a ground as: "a conducting connection, whether intentional or accidental between an electrical circuit or equipment and the earth, or to some conducting body that serves in place of the earth." When talking about grounding it is actually two different subjects, earth grounding and equipment grounding. Earth grounding is an intentional connection from a circuit conductor usually the neutral to a ground electrode placed in the earth. Equipment grounding is to ensure that operating equipment within a structure is properly grounded. These two grounding systems are required to be kept separate except for a connection between the two systems to prevent differences in potential from a possible flashover from a lightning strike. The purpose of a ground besides the protection of people plants and equipment is to provide a safe path for the dissipation of Fault Currents, Lightning Strikes, Static Discharges, EMI and RFI signals and Interference.

Improper grounding can create a lethal hazard. Correct grounding is essential for correct operation and safety of electrical equipments. Grounding can solve many problems, but it can also cause new ones. One of the most common problem is called "ground loop".

What causes the humming in audio systems ?

Audio and video systems need a reference point for their voltages. Generally referred to as common or ground, although it may not be actually connected with the earth, this reference remains at "zero volts" while other signal voltages "swing" positive (above) and negative (below) it. Physically, the common may be a wire, a trace on a printed-circuit board, a metal chassis, virtually anything that conducts electricity. Ideally it should be a perfect conductor, but in any practical system it is not. As the complexity and size of the system is increased, the imperfect conductivity of the common (ground) conductor inevitably causes problems.

Hum and buzz (50Hz/60Hz and it's harmonics) occur in unbalanced systems when currents flow in the cable shield connections between different pieces of equipment. Hum and buzz can also occur balanced systems even though they are generally much more

The cable shield currents and ground voltage differences are caused by several mechanisms. The second most common source of hum and buzz is the voltage difference between two safety grounds separated by a large distance or the voltage difference between a safety ground and an "Earth" ground (such as a grounded satellite dish or cable TV source). This problem is usually called "ground loop". This is the most common one in severe humming problems.

Hum and buzz can also be magnetically induced or capacitively induced directly into signal cables. Or the noise current can leak from mains input through capacitance between the A.C. power transformer primary and secondary windings which causes that a portion of the A.C. line voltage will ALWAYS be capacitively coupled directly to audio circuit ground. This capacitively coupled power line signal will usually contain significant harmonics out to 1MHz or more. These signals will cause currents to flow in the cable shields thus adding this noise directly to the audio signal.

Why grounding without problems is do difficult ?

Virtually all data and broadcast construction projects run into problems of grounding. These problems occur primarily because there is a conflict between issues of safety (ground- ing to prevent electrical shock) and electronic noise reduction (using "ground" as an electronic "dump" for noise and inter- ference.) These two uses are often not compatible and can sometimes be in direct conflict with one another. The ultimate purpose of good groundind scheme is he preservation and adherence to the safety aspects while obtaining the maximum noise reduction possible. That is not usually an easy task to do.

Why ground loop is a problem ?

Ground loops are a mystery to many people. Even college-trained electronic engineers may not know what ground loops actually are. Engineers have either concentrated on power distribution (for the electric company) or on equipment that happens to plug in to the power distribution system. Not much thought has been given to power distribution and equipment as a single entity where ground loops arise.

Ground loops are the most common cause of AC line frequency hum in sound systems. Ground loops can be geenrally identified by a low hum (60Hz in the US, 50Hz in Europe) through the sound system. A ground loop in the power or video signal occurs when some components in the same system are receiving its power from a different ground than other components, or the ground potential between two pieces of equipment is not identical.

Ground loop is a common problem when connecting multiple audio-visual system components together, there is a good change of making a nasty ground loops. Ground loops commonly cause humming noise to audio signals and interference bars to picture. Ground loop makes the system sensitive to pick up interference from mains wiring which can lead to erratic operation of the quipments or even damages to the equipments. Some articles claim that wiring and grounding problems account for up to 80 percent of all power quality related problems related with sensitive electronic equipments like audio/video systems.

The audio/video and power industries have each designed their systems and equipment independently. As a result, there's a degree of incompatibility. Usually which is pwefectly adequate in power distribution and operation safety sense is not good enough for AV-systems. Ground loop interference problem is a consequence of this.

Always when operating with grounding issues **remember that there is no absolute ground**. There is a certain amount of resistance to electrical current between all grounding points. This resistance can change with humidity, temperature, connected equipment and many other variables. No matter how small, the resistance can always allow an electrical voltage to exist across it when there is any current flowing between those grounding points (and there is some current flowing almost always).

Audio-frequency groundloop problems are typically in the low millivolt range, so it does not have to be much interference in grounding system to cause problems in audio systems.

Remeber that there is no absolute ground. There is a certain amount of resistance to electrical current between all grounding points. This resistance can change with humidity, temperature, connected equipment and many other variables. No matter how small, the resistance can always allow an electrical voltage to exist across it. The ground wires between wall sockets and power company transformers are not perfect conductors and neither is the shield of your coaxial video cable. If they were, ground loops would not be a problem. Effects of ground loop in video pictures are in the form of a black shadow bar across the screen or as tearing in the top corner of a picture. This is caused by different earth potentials in a system.

General topics

- [Why grounding is used in electrical wiring](#)
- [Basics of groundloops](#)
- [Cable shield connections and groundloops](#)
- [Electrical wiring in buildings](#)
- [Examples of different AV system with and without ground loop problems](#)
- [How the signal cable grounding is done in typical AV equipments](#)
- [Mains connectors](#)
- [Naming Electricity System Earthing Arrangements](#)
- [Solving typical home AV system ground loop problems](#)
- [Other than ground loop related sources of humming](#)
- [Why do you have to use a separated conductor for grounding and for neutral?](#)

Consumer audio and video systems

- [Audio signal grounding in audio equipments](#)
- [Solving AV problems in typical home system](#)

Professional audio systems

- [Why professional sound systems suffer from ground loop humming](#)
- [Advice on setting up hum free safe PA system](#)
- [Balanced power systems](#)
- [How to correctly wire audio equipment racks](#)
- [Methods for breaking ground loop](#)
- [Reducing microphone hum](#)
- [Wiring audio equipment racks and studio](#)
- [Ground lift circuits](#)
- [Audio isolation circuits and how to build your own](#)
- [Digital audio and groundloops](#)
- [Grounding and Rack Installations](#)

Professional video systems

- [Antenna cable isolators and how to build your own](#)
- [Ground loops in video systems](#)
- [Grounding and Rack Installations](#)

Data networks

- [What causes computer problems](#)
- [Datacom isolation](#)
- [Mains isolation possibilities](#) - and why does it not help always

Laboratory environment

- [Mains isolation possibilities](#)

Design tips

- [Design tips for balanced audio connections](#)
- [Ground loops inside circuits](#)

Other related information

- [Other noise and hum sources than groundloops](#)

Useful links to other sites and articles

General tutorials

- [Curing Ground Loops](#)
- [Grounding](#) - tutorial on grounding and groundloops
- [Ground Loops: What They Really Are](#) - ground loops are a mystery to many people
- [Using Grounding to Control EMI](#) - grounding issues in general and for medical equipments, describes ground loops well
- [What is a ground loop?](#)

Electrical mains wiring grounding issues

- [Grounding](#) - multipart article on electrical system grounding issues with view to safety and noise issues, three part article in the end of [Cherryland Amateur Radio Club](#) online magazine Cherry Juice, read [part 1](#), [part 2](#) and part 3
- [Grounding and Wiring for Electronic Equipment](#) - general installation on grounding practices in electrical distribution systems
- [Ground Resistance Principles, Testing, Techniques & Applications](#)
- [Isolated Grounding](#) - a technique often used with sensitive electronic equipment in USA to reduce common mode noise
- [Testing grounding conductors and grounding electrodes](#)
- [The Hows and Whys of Isolated Grounding](#) - in isolated grounding receptacle grounding terminals are electrically insulated from the receptacle mounting, insulating the receptacle grounding circuit from the metallic conduit grounding system when the receptacle is installed in a metal outlet box to reduce noise interference
- [Two Modern Power Quality Issues - Harmonics & Grounding](#)

Audio and video systems installations

- [A Clean Audio Installation Guide](#) - by [Benchmark Media Systems](#)
- [Balanced Line Technology](#) - technical description of audio connections used in professional audio systems
- [Grounding and Shielding for Sound and Video](#)
- [Clean Signals: Pitfalls in Audiophile Systems](#) - for most designers, technicians and users, system interfacing and grounding practices are considered a black art, but this column is intended to increase your understanding of these interfaces and offer guidelines for preventing and solving the inevitable real-world problems
- [Hum & Buzz in Unbalanced Interconnect Systems](#) - pdf file
- [Interconnection of Balanced and Unbalanced Equipment](#)
- [Keeping Quiet](#) - learn to handle hum and buzz with a critical look at system noise from the ground up
- [Power & Grounding for a Post Facility: Unconventional Approaches](#) - describes concepts like lean tech power and balanced power
- [Sound System Interconnection RaneNote 110](#) - describes the correct wiring methods for different audio cables
- [Understanding Ground Faults/loops](#)

Problem solving

- [Getting Hum & Noise to BUZZ OFF! - EARTHING](#)
- [Deerfield Lab: Ground Loop Analysis and Solutions](#) - information on video interface ground loops
- [Do You Hear Something? - Eliminating Hums and Buzzes](#)
- [Earthing Your Hi-Fi - Tricks and Techniques](#)
- [Equipment Maximization through Electrical Minimization](#) - tips for finding out ground loop problems, some solving methods are questionable because of grounding safety issues
- [Fixing Cable-TV Hum in Audio Systems](#)
- [Ground Loops and Autosound Systems: Tracking Down Ground Loops](#) - technical paper in pdf format
- [Ground Loops \(or "Let Me Hum a Few Bars..."\)](#) - information on ground loop problem solving on home theater setup
- [Ground Loops, or let me hum a few bars](#) - many home theatre, video and audio systems hum, usually a result of the matching of components, their earthing scheme and the power lines within your home
- [ISO-MAX Troubleshooting Guide](#) - contains lots of useful technical information on groundloops and troubleshooting tips
- [Kill Studio Hum and Buzz at the Source](#) - article will address some common causes of hum, and describe ways to reduce it or even eliminate it entirely

- [My system hums, what should I do?](#)
- [Solutions for Ground Loop Interference](#)
- [Thoughts of a road-technician](#)

Equipment design

- [A New and Important Audio Equipment Evaluation Criteria](#) - what kind of equipments are potential noise problem makers
- [Audio Transformer: The Ultimate Noise Killers](#) - application note article on audio transformers
- [Considerations in Grounding and Shielding in Audio Devices](#) - engineering report from [Rane](#) in pdf format
- [Proper Grounding Inside Equipment Avoids Ground Noise Coupling \(aka "Pin 1 Problems"\)](#) - 15KB PDF
- [Star Grounding](#) - one of the best amplifier power supply grounding schemes is a "star" ground system, where all the local grounds for each stage are connected together, and a wire is run from that point to a single ground point on the chassis, back at the power supply ground

Useful sites

- [Electrician's Toolbox Etc.](#) - this site is for the electrician

Car sound systems and groundloops

- [Ground Loops and Autosound Systems](#)

Where all this information comes from ?

Most of the information comes from my personal personal knowledge on the field. I have had experience on designing, building, using, maintaining and faultfinding many audio, video and computer network systems. I have also designed electronics devices for audio, video and telecommunication applications.

When I have found stange problems on those systems I have tried to make a good investigation what is the cause of the problem and what are the sensible ways to solve the problem. Various books, magazine articles and technical documents from many web sites have been also been very useful when I have put this web document together.

If you have some comments on this page mail them to me to tomi.engdahl@iki.fi.

[Tomi Engdahl](#) <Tomi.Engdahl@iki.fi>

Why grounding is used ?

Terminology

In Britain, people have 'earth' and in Northern America they have 'ground'. They are exactly the same thing, only different terms are used in different countries.

Purposes of Grounding

Grounding system has three main purposes:

Overvoltage protection

Lightning, line surges or unintentional contact with higher voltage lines can cause dangerously high voltages to the electrical distribution system wires. Grounding provides an alternative path around the electrical system of your home or workplace minimizes damage from such occurrences.

Voltage stabilization

There are many sources of electricity. Every transformer can be considered a separate source. If there were not a common reference point for all these voltage sources it would be extremely difficult to calculate their relationships to each other. The earth is the most omnipresent conductive surface, and so it was adopted in the very beginnings of electrical distribution systems as a nearly universal standard for all electric systems.

Current path in order to facilitate the operation of overcurrent devices

This purpose of grounding is the most important one to understand. Grounding system provides certain level of safety to humans and property in case of equipment damages.

Grounding operation in electrical distribution network

The main reason why grounding is used in electrical distribution network is the safety: when all metallic parts in electrical equipments are grounded then if the insulation inside the equipments fails there are no dangerous voltages present in the equipment case. Then the live wire touches the grounded case then the circuit is effectively shorted and fuse will immediately blow. When the fuse is blown then the dangerous voltages are away.

The safety is the primary function of grounding. Grounding systems are designed so that they do provide the necessary safety functions. Grounding also have other functions in some applications but the safety should not be compromised in any case. Grounding is quite often used to provide common ground reference potential for all equipments but the existing building grounding systems might not provide good enough ground potential for all equipments which might lead to ground potential difference and ground loop problems which are common problems in computer networks and audio/video systems.

How electric shock happens

The "hot" wire is at 120 volts or 230 volts (depends on the mains voltage used in your country) and the other wire is neutral or ground. If a person were to touch the neutral wire only, no shock would result simply because there is no voltage on it. If he were to touch the hot wire only, again nothing would happen to him unless some other part of his body were to become grounded. A person is considered to be grounded if he comes in contact with a water pipe, metal conduit, the neutral or ground wire, or stands barefoot on a concrete floor.

In other words, neither wire is a shock hazard unless a person is grounded, and then only the hot is a potential shock hazard. Of course, if a person were to touch both wires at the same time, he would be shocked simply because his body is completing connection between "hot" and "ground" wires.

Metal case safety

Back in the early days, equipment and appliances fitted with the two wire power plug were readily accepted to be safe from shock hazard because the metal housing was not connected to either wire of the line cord (called floating case).

One of the problems with appliances and equipment which have a "floating metal case" is that a shock hazard exists if the case comes into contact with the hot wire. This so called "fault condition" may happen in many ways with some of the more common causes being a "pinched" line cord, failure of installation systems, or movement of components due to shock or vibration which will cause the "hot wire" terminal to touch the case.

Naturally, if for any reason the case does become "live," then a person touching it may be shocked if he is grounded. If this "hot chassis" is connected to another chassis or instrument by a typical shielded cord, then that chassis or instrument will become hot also. The entire purpose of the present three wire system is to provide a separate ground path which will effectively eliminate any possibility of shock.

If the live wire touches the grounded metal case the ground connection in the case causes that the situation becomes a short circuit as drawn in picture below.

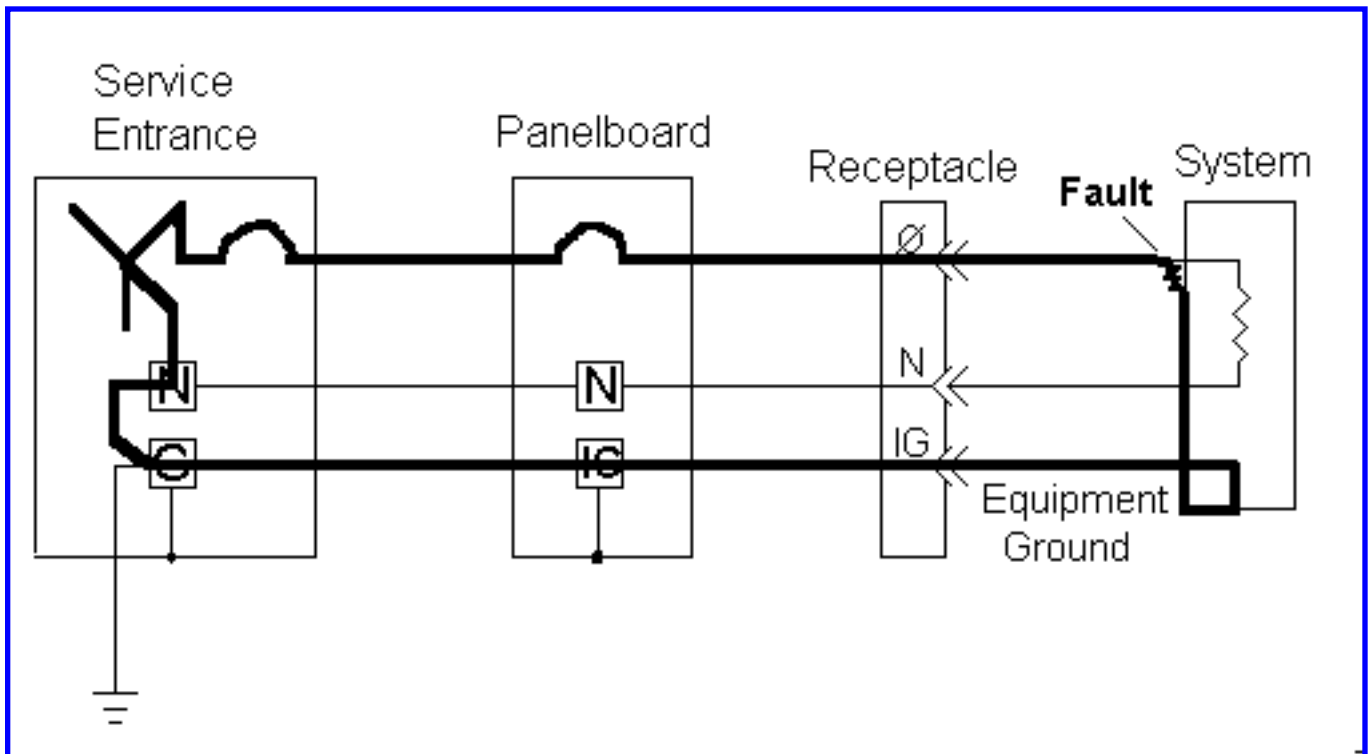

This short circuit situation causes very high current surge to flow in the circuit which will cause the distribution panel fuse to blow almost immediately. The current in short circuit situation can be pretty high because of the low resistance of the mains distribution wiring.

The integrity of the separate ground path is directly related to the quality of the chassis/green wire/ground pin combination. When the ground pin is removed, the separate ground path is destroyed and then fault conditions may cause shock hazards.

Grounding and interference susceptibility

Whenever audio equipment is operated without a ground (floating chassis), strange things can happen. Under certain conditions the amplifier will be more susceptible to radio frequency interference (picking up radio stations or CB. radio). Also, without a suitable ground, amplifiers sometimes "hum" more when the musician picks up his instrument and provides a "pseudo" ground through himself.

The only solution is to find a ground point to connect to the chassis. Sometimes this may just cause more problems than it helps.

Grounding in wiring

Today's modern (US.) mains cable consists of three separate wires: black, white, and green. The green wire is always connected to the large ground pin on the plug, and the other (green) end connected to the chassis of the equipment. The black wire is always considered to be the "hot wire," and as such, is always the leg which is connected to the switch and fuse. The white wire is always the neutral or common wire.

European coloring is a little bit different. The ground wire is here green wire with yellow stripe. Neutral wire is blue. Live wire in Brown (additional colors for the live wires used in 3 phase systems are black and black with white stripe).

Any modification of the above 3 wire mains system completely eliminates the protection given by the three wire configuration. The integrity of the separate ground path is also directly related to the quality of the receptacle and the wiring system in the building itself.

The neutral (grounded conductor) must be solidly connected (bonded) to the home's ground system at the first disconnect (main panel). This keeps large voltage differences from developing between the neutral and ground.

Currents in grounding wire

Ground wires should not carry current except during faults. If the ground wire carries any current there will be a potential difference between different grounding points (because the current flowing in wire causes voltage drop because wire resistance). This is why a common wire which works as neutral and grounding wire is very bad thing.

When there is separate wiring for grounding you can't still completely avoid the current flowing in grounding wires ! There will always be some capacitive leakage current from the live wire to the ground wire. This capacitive leakage current is caused by the fact that the wiring, transformers and interference filters all have some capacitance between the ground and live wire. The amount of current is limited to be quite low (limited to be between 0.6 mA to 10 mA depending on equipment type) so it does not cause dangers and big problems. Because of this leakage current there is always some current flowing in the ground wire and the ground potentials of different electrical power outlets are never equal.

The leakage current can also cause other type of problems. In some situations there are ground fault detect interrupter (GFCI) circuits in use the leakage current caused by many equipments together can make the GFCI to cut the current. Typically GFCI circuits are designed to cut current when there is 30 mA or more difference in currents flowing in live and neutral wires (the difference of those current must flow to ground). Some GFCI circuit can cut the mains feed even at 15 mA leakage current which may mean that if you connect many computer equipments (each of them having 0.5 to 2 mA of leakage) to GFCI protected power outlet you can cause the GFCI to cut the power feed.

Ground wire resistance

In europe it is not important how much ohms the grounding is but the maximum current before the unit switches off is important. So a grounding of 230 volts and a safety of 24 volts. We say it must be less then 30 mA in our body. So for 16 amps and 24 volts it is 1.5 ohms. This means that the maximum voltage on the case is 24 volts even when all current is flowing thru the grounding wire. In places where even this 24V is considered very dangerous (for example in hospitals) the ground resistance must be made lower to make sure that there is never dangrous voltage present in the case. For example in Finland the grounding resistance for medical room outles must be less than 0.2 ohms to be considered safe.

The above is the objective, and all the crap around it is just to make it difficult. Ground means something connected to the surrounding and it must be less then x ohms measured with AC and the wire must handle the short circuit current present in the circuit without overheating.

Sources

- [Frequently Asked Questions on Electrical Wiring](#) by Chris Lewis and Steven Bellovin
- [Grounding article](#) from [CodeCheck.com](#)
- Shock Hazard and Grounding by Jack Sondermeyer from [Peavey](#) (web document which is no longer available)

Other useful grounding links

- [Why Ground ?](#) - from [Q & A Electrical](#) from [CodeCheck.com](#)
- [The shocking story of grounding](#)
- [Two Modern Power Quality Issues - Harmonics & Grounding](#) from [Copper Building Wire](#) home page
- [Residential Wiring and Grounding Guidelines](#) from [Power Clinic](#)

- [The Hows and Whys of Isolated Grounding](#)
- [United States Practices to Protect People and Equipment Against Lightning](#) from [Power Quality magazine](#)

[Tomi Engdahl](#) <Tomi.Engdahl@iki.fi>

Published by ELH Communications Ltd. all rights reserved.

Ground loop basics

What is ground loop ?

A ground loop occurs when there is more than one ground connection path between two pieces of equipment. The duplicate ground paths form the equivalent of a loop antenna which very efficiently picks up interference currents. Lead resistance transforms these currents into voltage fluctuations. As a consequence of ground-loop induced voltages, the ground reference in the system is no longer a stable potential, so signals ride on the noise. The noise becomes part of the program signal.

Ground loop is a common wiring conditions where a ground current may take more than one path to return to the grounding electrode at the SERVICE PANEL. AC powered computers all connected to each other through the ground wire in common building wiring. Computers may also be connected by data communications cables. Computers are therefore frequently connected to each other through more than one path. When a multi-path connection between computer circuits exists, the resulting arrangement is known as a "ground loop". Whenever a ground loop exists, there is a potential for damage from INTER SYSTEM GROUND NOISE.

A ground loop in the power or video signal occurs when some components in the same system are receiving its power from a different ground than other components, or the ground potential between two pieces of equipment is not identical.

Usually a potential difference in the grounds causes a current to flow in the interconnects. This in turn modulates the input of the circuitry and is treated like any other signal fed through the normal inputs. Here is an example situation where two grounded equipments are interconnected though signal wire ground and the mains grounding wire. In this situation there is 1A current flowing in the wire which causes 0.1V voltage difference between those two equipment grounding points.

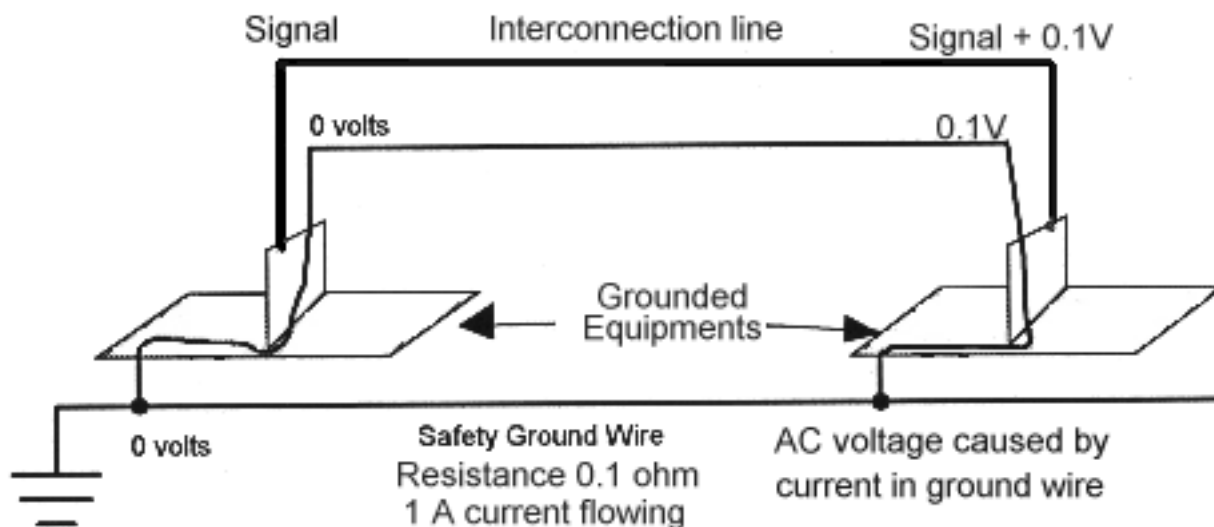

Because there is voltage difference between the equipments, the signal in the interconnection wire sees that difference added to signal. This can be heard as humming noise on the wire because the AC current cause the voltage difference of those ground potentials to be also AC voltage. This is one reason for this 50 Hz or 60 Hz noise you hear in the audio signal (or see in video signal as annoying horizontal bars).

Another problem is the current flowing in the signal cable grounding wire. This current passes through the cable and through the equipment. Of the way the current passes is not well designed this can cause lots of noise to the equipment or other kind of problems (like computer lockups). **Lots of designers count on ground being ground and do not optimize their design to eliminate their sensitivity to ground noise.** If you are a product designer remember to take care that ground loop current does not cause problems in your equipment by designing proper grounding scheme inside the equipment.

Why ground loop is a problem ?

Ground loop is a common problem when connecting multiple audio-visual system components together, there is a good chance of making a nasty ground loop. Ground loop problems are one of the most common noise problems in audio systems. Typical indication of the ground loop problem is audible 50 Hz or 60 Hz (depends on mains voltage frequency used in your country) noise in sound. Most common situation where you meet ground loop problems are when your system includes equipment connected to earthed electric outlet and antenna network or equipments connected to different grounded outlets around the room.

Everything connected to a single mains earth, which is usually connected to all the earth pins in all the power sockets in one room. Then antenna network is also grounded to same grounding point. This would normally be okay, as the grounding is only connected to each other in a star-like fashion from a central earth wire (leading to the real Earth via a grounding cable or metal pipe) earth cables run through your power cables into the equipment.

Once you take into account that some of your equipment is linked with shielded cable you are quite likely to face some problems. Currents could quite possibly run from one piece of equipment, into the earth cable, into another piece of equipment, then back to the first piece via a shielded audio cable. That wire loop can also pick up interference from nearby magnetic fields and radio transmitters.

The result is that the unwanted signal will be amplified until it is audible and clearly undesirable. Even voltage differences lower than 1 mV can cause annoying humming sound on your audio system.

A problem with audible noise coming from your audio system when other electronic components (fridge, water cooler, ect.) could be the result of a contaminated ground/neutral conductor in your A/C wiring and a ground loop in your audio system. This can happen when certain type of devices come on. Typically their power supplies are non-linear and throw garbage back onto the neutral and/or ground conductors. Usually line conditioners or UPS devices will not do anything to help solve this problem.

Common Causes for Computer System Problems

Many times when a user thinks that his system is 'bad' or has 'gone bad' the fault is electrical or magnetic in nature. Monitor problems are very often caused by nearby magnetic fields, neutral wire harmonics, or conducted/transmitted electrical noise. Intermittent lockups of computers are very often caused by a Ground Loop, an electrical phenomena that sometimes manifests itself when a system and its peripherals are improperly plugged into **different** electrical circuits. Many don't even know if their wall outlet is properly wired and grounded, an absolute necessity for a computer and peripheral to operate reliably and safely.

Have you ruled out Ground Loops in your computer system ? Ground loops can cause problems to LAN connections if not properly wired. A ground loop caused by RS-232 connection to other computer can cause computer lockups.

When ground loop is not a problem

Ground loop does not cause problems when all of the following things are true:

- None of the wires in the loop carry any current
- The loop is not exposed to external changing magnetic fields
- There is no radio frequency interference nearby

If there is any current flowing in any wires, there is then some potential difference which causes current to flow in other wires also which causes problems. The loop will also act as coil and pick current from the changing magnetic fields around it. Wire loop acts also like an antenna picking up radio signals.

What size of ground potential difference problems we are talking about ?

Literature is speaking about Common Mode Noise of 1 to 2 Volt in "well grounded" plants and over 20 Volts in "poorly grounded" plants. Literature is also speaking of the current measured on a main service grounding (in a large building) in terms of Amps.

Where does this current and voltage difference come from ?

Current leakage of condensators between hot and ground and between neutral and ground, in for instance main filters, cause current in ground wires (and ground loops). The leakage current is typically measures in milliamperes (typically less than 1 mA in computer equipments) per equipment. When you sum up maybe hundreds of such equipments you can easily get amperes.

The capacitance between line and ground of large heaters and motors, for example, can be much larger than the capacitance in filter capacitors. Currents from this source are usually of the order of 1 amp (rather than 0.1 A or 10 A)

Even a very small induced voltage can cause a very large current in a ground conductor loop, because the resistance (and inductance) are very low. These currents can indeed be tens of amps. Current induction can be caused for example by cables carrying high currents and from transformers.

What those grounding currents and voltage differences can do ?

Small voltage differences just cause noise to be added to the signals. This can cause humming noise to audio, interference bars to video signals and transmission errors to computer networks.

Higher currents can cause more serious problems like sparking in connections, damages equipment and burned wiring. My own experience on th field is limited to sparking connectors, heating cables and damaged computer serial port cards. I have read about burned signal cables and smoking computers because of the ground differentials and large currents caused by them. So be warned about this potential problem and do not do any stupid installations.

[Tomi Engdahl](mailto:Tomi.Engdahl@iki.fi) <Tomi.Engdahl@iki.fi>

Cable shield connections and groundloops

There are sometimes lots of talk about how the cable shields should be connected when the equipments are interconnected. Some arguments say that to avoid ground loops is a good idea to connect the cable shield only at one end to avoid large ground currents on cable shield. On the other hand EMC books and text talk about how important is to connect the cable shield on both ends to get good shielding against interference trying to get out from the cable and into the signal in the cable from external sources. Cable shield connections are still controversial. There are strong, valid arguments both ways.

For cable shield connections there are four options, with advantages and disadvantages:

1. Shield grounded at both ends: Good r.f. shielding but susceptible to ground loop currents that can be VERY large - up to at least 100 A in bad cases.
2. Shield grounded at both end, with large-area parallel bonding wire: Good at r.f. and now the ground current flows mainly through the bonding wire, but the intense magnetic field that may result is not good news. The bonding wire size needs to be, for example, 10 mm².
3. Shield grounded at one end only: No ground current but not good at radio frequencies for which the cable is more than 1/8 wavelength long. R.F. interference may actually be worse than for an unshielded cable.
4. Shield grounded at the sending end and grounded through a capacitor (may be two in parallel, for effectiveness from about 100 kHz up to 1 GHz and beyond) at the receiving end: Good at r.f. if the capacitor type and positioning are correctly-designed, and no low-frequency ground current. One capacitor needs to be of the type with an integral spark-gap so that it is not damaged by transient high-voltage spikes that may be induced on to the shield.

What wiring practices are used in practice

The professional lighting and sound industries generally favour solution 4, based on practical experience of what works and is reliable. There are also 'ground both ends' people in sound industries who remain unconvinced of this and use option 1. Video industry generally favours option 1.

When considering the wiring for other application you need to consider following things:

- What are the chances of large earth currents?
- What are the chances of excessive emission from cables whose screens are not earthed at low frequencies at both ends?

What's the problem in grounding systems used in buildings ?

NOTE: This documents tries to give you general information about electrical wiring inside building. This documents is only written to give a general understanding of some of the most common electrical wiring systems. This document is not ment to be an accurate description of all wiring systems. Don't do any electrical work based on information provided here. Leave the work to professionals who know all this and the local regulations.

Building grounding

In the construction of most commercial buildings, one ground is usually run throughout the building to keep the impedance as low as possible. Low impedance in the ground is needed to make sure that the fuse blows when something gets short circuited to ground wire (for example cable insulation breaks inside the equipment and touches the grounded metal case). The grounding system is primarily designed for electrical safety in mind. The Protective Earth connection should be able to carry a heavy current to protect the user from live-to-chassis faults by ensuring that the fuse or circuit breaker will operate so the requirement is that the Protective Earth conductors can carry a 25A fault current for at least 1 minute. The grounding system in the building electricity distribution has only effect on the electromagnetic environment inside the building which you must understand.

Unfortunately all building have big electrical equipment such as air conditioning units, refrigerators, washers/dryers and other high current devices connected to the building ground (the same ground you use for your AV system). Computers and other equipments which use stiched power supplies generate harmonics to the electrical power which usually end up being noise in the grounding system. Light dimmers are also a strong source of interference and some of it typically ends to the ground wires also. Thus the chances of getting a clean ground in a typical audio visual installation is slim, especially in large commercial buildings, hotels, hospitals or convention centers.

Grounding practices in buildings

Electric power distribution throughout Finland and many parts of Europe is made by 230/400Vac, 3 phase, four wire, Multiple Earth Neutral (MEN). One, two or three phases are brought into the customer's premises depending on the maximum demand. This applies to both residential and business premises.

For those not aware of the MEN system, the neutral bar is connected to an earthing stake driven into the ground as near as possible to the customer's switchboard. All earth wiring from power points, etc. is connected to the neutral bar. In the UK the same practice is called Protective Multiple Earthing (PME). With P.M.E. the neutral and earth conductors of the supply are combined. The supply company connects the neutral solidly to earth frequently throughout the distribution network. At the customer's connection point the company supplies an 'earth' (which is actually connected to the neutral) to which all the installation earths and equipotential bonding are connected.

Another approach to bring grounding to the building is to bring it through armouring of the supply cable. If the electricity company cannot easily supply or guarantee an adequate earth conductor (for example supply comes on a pair of overhead wires), the ser is generally responsible for the adequacy of the earth electrode. The method of earthing can normally be found out by tracing the wiring from the meter/consumer unit. It is usually fairly obvious.

How Good Should the Earth Be ?

This is a difficult question to answer; in general the impedance of the earth connection must be low enough to ensure that sufficient current can flow through the protective device so that it disconnects the supply quickly (<0.4 second) and that voltage on the earth connection does not rise more than 50V. Measuring the resistance of an earth electrode is not easy and should be left to professionals.

Safety if the neutral in the feeding is cut

How safe or unsafe MEN or PME is depends on the rules which cover its application, and the record of the supply utility in avoiding neutrals going open circuit.

The key word in the titles is MULTIPLE. The exact situation will vary dramatically depending on where the break in the neutral occurs. If it is just outside the substation, then the neutral conductor will be replaced by all of the multiple earths in parallel, and providing the load is balanced over the three phases, the voltage disturbance will not be too serious.

When the supply company neutral goes open, the neutral return is via the earth stake. Soil types here range from sand to loam to clay to rock, so the ground stake can range from a good to a very poor earth. The voltage from each active to the "neutral" will depend on the loads on each phase and the ground resistance.

The worse the balancing of your load over the three phases, the worse the voltage disturbance will be. If we assume that the earthing spike has a resistance of 100 ohm, it is pretty clear that your equipment is not going to work, but your neutral and earthed metal work is going to rise to something near to phase voltage. This sound horrific, but is actually not dangerous provided that all earthed metal work is nicely bonded, and there are no unbonded earthed objects around that are better earths than your earth spike.

How the ground connections are made in the main distribution board

The three phase power comes from power company using just four wires L1, L2, L3 and PEN (protective earth and neutral). L1, L2 and L3 are just connected to the power bars in the main distribution panel. The PEN wire is connected to the PE (protective earth) bar which is connected to the central grounding bar. Neutral bar is connected to the PE bar in the main distribution panel and nowhere else in the building which has 5 wire 3 phase wiring.

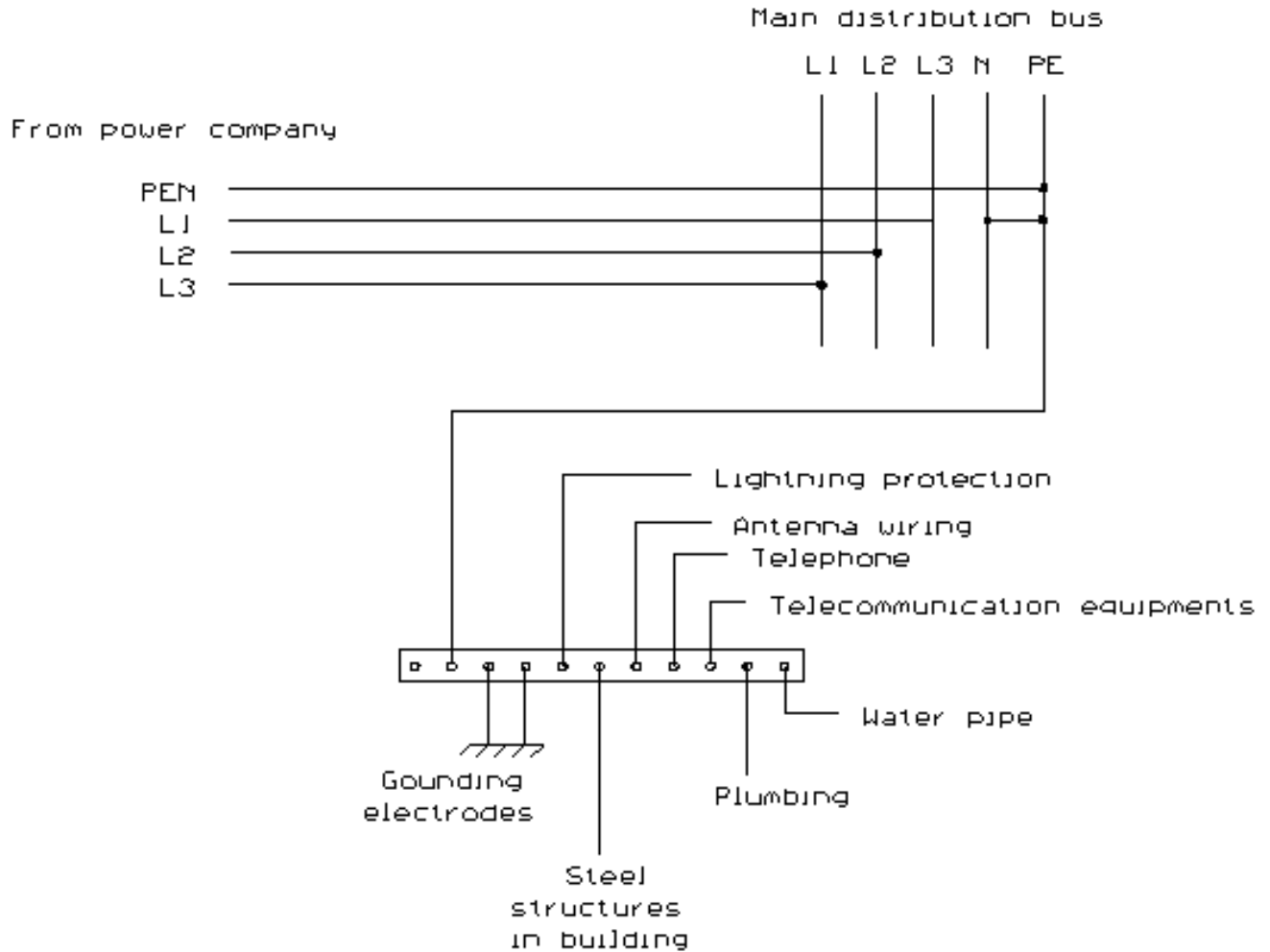

The central grounding bar works as the central point for whole building grounding system and every grounded system in the building is connected to it. The central grounding bar is just a metal bar which connected the grounding wires from the mains power, telephone equipments, antenna wiring, lightning protectors, metal plumbing, water pipes, building steel structures and building grounding electrodes together.

As mentioned elsewhere, a fault current flowing in the earth wiring will cause the voltage on that wiring to rise relative to true earth potential. This could cause a shock to someone touching, for instance, the case of a faulty washing machine and a water tap at the same time. In order to minimise this risk, an 'equipotential zone' is created by connecting the services to the main earthing point. Such services are metal pipes (gas, water, etc.), central heating, metallic ventilation trunking, exposed parts of building structure, lighting conductor and any other metallic service.

The equipotential bonding reduces the voltage difference which could exist between the metalwork of these services if an earth fault occurred to any one of them.

How the ground is wired to electrical outlets

The best way would be to run all the grounds separately back to a single block of copper at the central grounding bar. Unfortunately this is often difficult to achieve in practice. The practical way is to arrange your grounds as a strict 'tree' structure, with equipment only connecting to the leaves of the tree.

For ground wire routing the electrical installation regulations worldwide generally state that the ground wires should be routed on the same route than the mains current carrying wires going to the same outlet or distribution panel. This is the most often used practice. Usually the safety ground is a separate yellow/green wire in the cable and sometimes it is a separate wire in the same cable bundle (for example for 3 phase distribution you might see sometimes a 4 or 5 wire cable and a separate safety ground cable bundled on the side of the cable). In some countries (for example in USA) in some case the metallic piping used to protect the mains carrying wire inside the walls can be used as safety ground conductor (not usually very good or reliable in practice I think, but is allowed in some cases).

How power is delivered to the house

Typical one phase feeding to building

One phase distribution is typically used in small residential building. The power company feed live wire and neutral+ground wire to your house. The power in the power company system is typically three phase power and the power company then feed one phase to your house (you neighbour can have their power from other phase for even distribution of load).

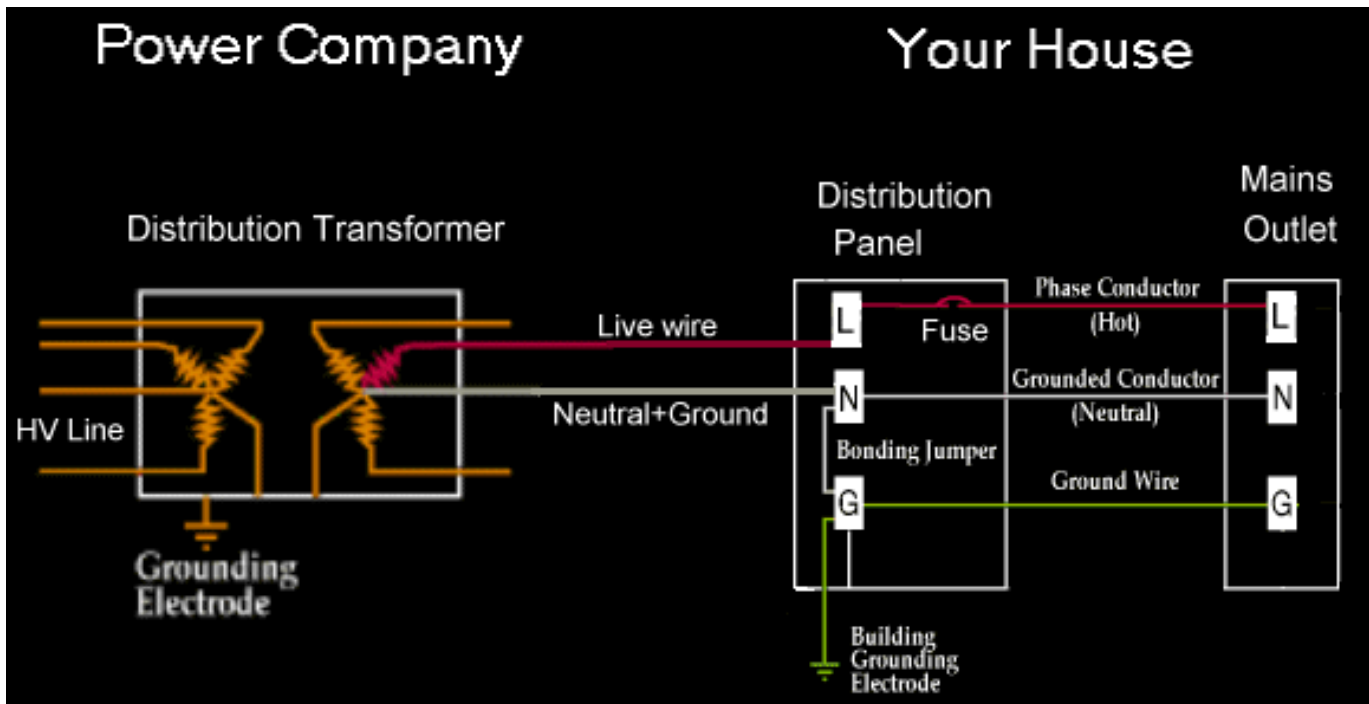

Single phase power in North America

ANSI C84.1 "Electric Power Systems and Equipment - Voltage Ratings (60 Hz) sets the preferred nominal voltage at 120V and allows a range of 114 - 126V (240V nominal, range 228 - 252V). Equivalent Canadian spec is CAN3-C235.

Voltage at a 120 volt nominal single phase receptacle should be 110 to 125V under normal conditions.

However, the California Public Utilities Commission has specified that the service voltage shall be kept in the range 114-120V, with some exceptions. This was done because some studies showed a reduction in energy consumption at the lower voltages.

Information on NEMA plug configurations is available in NEMA Configuration Chart, Form No. H4513. For availability check <http://www.hubbell-wiring.com/>.

Single phase power in Europe

The nominal European voltage is now 230V 50 Hz (formerly 240V in UK, 220V in the rest of Europe) but this does not mean there has been a real change in the supply.

Instead, the new "harmonised voltage limits" in Europe are now:

- 230V -10% +6% (i.e. 207.0 - 243.8V) in most of Europe (the former 220V nominal countries)
- 230V -6% +10% (i.e. 216.2 - 253.0V) in UK (former 240V nominal)

this is really a fudge and means there is no real change of supply voltage, only a change in the "label", with no incentive for electricity supply companies to actually change the supply voltage.

To cope with both sets of limits an equipment will therefore need to cover 230V +/-10% i.e. 207-253V. This will actually become the official limit for the whole of the EU in 2003.

Single phase power in rest of the world

A listing of nominal voltage/frequency and plug/socket types used in many countries is given at <http://kropla.com/electric2.htm>.

Three phase distribution

The 3-wire system that the user sees is typically derived from three phase distribution, which uses a 5-wire system. In the 5-wire system, there are 3 hot wires, 1 neutral wire, and 1 grounding wire. The common 3-wire receptacle uses only one of the 3 hot wires. This 5 wire wiring system is basically good and it is used in most buildings and places where ground loops are expected to be a problem.

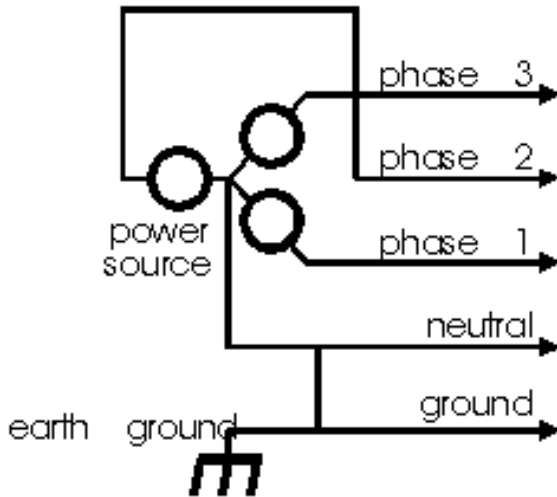

This three phase power system is called **THREE-PHASE STAR; FOUR-WIRE; EARTHED NEUTRAL** system. This is the most common way used in European wiring systems (and used almost everywhere in Finland), but note that three-phase distribution circuits come in several flavours. There is a distinct difference between those in the US and those in Europe. They are classified as follows:

- TN: Transformer star point earthed. Protective Earth and Neutral share the "ground" conductor (PEN) and are separated at the fuse panel. This circuit is also referred to as TN-C (C for common PE and N). In UK this is called TN-C-S (i.e. combined in supply and separate in the installation), and it is also referred to as Protective Multiple Earthing (PME - as the PEN supply conductor is grounded at regular intervals along the supply).
- TN-S: As above, but PE and N are brought separately all the way from the earthed transformer and never allowed to get into contact with each other elsewhere. The idea is that PE shall never carry any current (it shall consequently not carry any potential and is supposed to be very "clean". All return currents go through the N conductor all the way to the transformer star point. This system has become very popular in new installations in Europe and has been a standard in hospitals for a long time.
- IT: The transformer is not earthed at all. The star point floats. Mostly used in heavy and process industry where continued operation - even if there is an earth fault - is required. The more common (European) voltages in these systems are 500 V and 690 V. In this case housing of the objects are connected to local grounds.
- TT: Transformer and objects have separate grounds. Common in US.

Three phase in Europe

In Europe most use 230/400V where the 230V can be found between any of the 3 phases and neutral and the 400V can be found between two of the three phases. Phase difference between phases is 120 degrees. Three phase power is normally available in at least Finland, Sweden and Germany being used for ovens, electric stoves, large motors and dryers. Three phase power is also typically available in places where large sound and light systems are used (around stages etc.).

Typically there are 4 wires routed to every house for 3 phase feed. Those are typically they are labeled R, S, and T, the fourth being ground. The phase shift between R and S are 120 deg., the same phase shift exists between S and T and between T and R. The voltage difference between the live phases is 400 V, the voltage difference between any live phase and ground is around 235 V. The usual household power outlet connection uses one phase and ground. Three phase is usually used only on some permanently wired high power loads (typically ovens and electric stoves in normal household). A typical rating for mains fuse in typical household in Finland which has three phase power is 3x25A (25A per phase).

If three phase connector is available some heavy equipments (in places where heavy machinery is used), then the most common one available is 3x16A connection.

Other possibilities for power distribution

Some smaller electrical installations (small houses) only use one phase feed. In those cases the power company only brings one of the three phases to the house. In those cases the wiring from power company is implemented using two wires: "neutral+ground" and "phase". The frequency in USA is 60 Hz and nominal voltage in USA is defined in the following manner:

- 120 volts is the voltage at the transformer
- 115 volts is the voltage at the panel (voltage drop losses in the cable from the transformer to the panel)
- 110 volts is the voltage at the receptacle (voltage drop losses in the cable from the panel to the receptacle)

So if the outlets are very lightly loaded, you will get nearly 120V and if wiring heavily loaded, the voltage drops to around 110V. In Europe the frequency is 50 Hz and voltage on the outlet is nowadays is 230V (the real voltage typically is between 220V and 240V).

In USA the domestic service has typically 3 wires: 2 hots and a neutral. The voltage between the 2 hots is 240 and the voltage from either hot to the neutral is 120

(half). Normal electrical outlets are connected between the neutral and one hot wire. Some heavy loads (like air conditioners) are connected between those two hot wires and receive the full 240V load.

House wiring details

What does a typical power outlet look like ?

A typical office wall outlet has three electrical connections, which are the "hot", "neutral", and "grounding" wires.

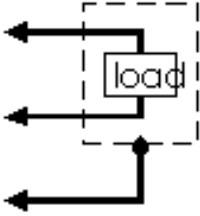

All office equipment requires only the hot and neutral wires to function. The third or grounding wire is connected to exposed metal parts on the equipment. Within the building, the grounding connections of all electrical receptacles are wired to one another and are connected to the water piping. This ensures that all electrical equipment with exposed metal parts has these parts electrically connected to each other and to exposed metal fixtures in the building such as water fixtures.

The hot and neutral wires are interchangeable as far as the equipment is concerned (be warned that there are some exceptions in some countries). Both are power carrying wires. One of the power carrying wires is grounded for reasons of safety. In many parts of Europe (nordic counties, Germany etc), the normal 3-wire receptacle is symmetrical so that the neutral and hot wire connections can be swapped by simply rotating the plug.



Earthing of Electrical Installation

Each circuit requires an earth conductor to accompany (but kept separate from) the line and neutral conductors throughout the distribution. All metal boxes should be connected to the earth.

What are the wire colors used in wiring

House wiring colors used in USA

Green body color	Grounding Conductor
White body color	Grounded Conductor (Neutral)
ANY other Body Color	Figure that it's HOT

Wiring colors used in equipment cables

GREEN with YELLOW stripes	Ground
BLUE	Neutral
BROWN	Live

Typical colors used in house wiring in Europe

Information of this is from regulations in use in Finland.

GREEN with YELLOW stripes	Ground
BLUE	Neutral
BROWN or BLACK	Live

Grounding (Green or green/yellow) means that it's there to tie all of the stray metal parts together so that (hopefully) none of them can get to where they'll make a hazard. A far better term for this wire is that it is the "Bonding" conductor. Grounding wire should NEVER be asked to carry current.

Do not trust the color coding unless you know under which standard the wiring is done. There are some other color codes also in use. Inside of any electronic equipment, it is dangerous to trust any color codes unless you know which "Standard" that unit was built under.

House wiring problems

Problematic old wiring

The most problematic are those buildings which are wired using 4 wire 3 phase wiring, where neutral and ground share the same conductor at some places of wiring. This is a bad thing because in this situation there will be always current flowing in the same wire which should distribute the same ground potential to different places. If your building has four wire 3 phase wiring you can expect quite noticeable ground potential differences of the power taken from different distribution panels.

The practice where safety ground is connected using the same conductor as neutral is called PEN (TN-C) and practice where there is separate ground wire in whole system is called PE (TN-S).

Two wire 1 phase grounded outlet

And worst of all is a 2 wire 1 phase jack wiring where neutral and ground share a common wire. This practice is very often used in older buildings in Finland and causes terrible ground loop problems even between nearby power outlets. If you are planning to install any dedicated equipments (computer connected to LAN, interconnected audio or video equipment etc.) to building which has this kind wiring system is advisable to get a licensed electrician to rewire the room with proper outlets. This wiring has also some other problems and that's why it is not allowed anymore in new installations in Finland.

Circuit breaker boxes: The main breaker box to the building is the single location where the neutral and the ground wires come together. The electrical service will be grounded at this point. **IN ALL DOWNSTREAM BREAKER BOXES BOTH THE NEUTRAL AND GROUND WIRES MUST BE KEPT APART FROM ONE ANOTHER.** Otherwise you will have neutral currents flowing on the ground wire. This is extremely important and is a major safety and signal issue.

These simple rules apply to ALL cabling including CATV, Video, AC and signal. One exception is the ethernet. Ground the computer LAN one end (preferably to the same point as your audio system) and make sure that the thin ethernet connector metal parts do not touch any parts of computer case (there are nice plastic isolation cases available for them). I would recommend to use 10 Base-T ethernet which used twisted pair wiring because it does not need any grounding and does not cause ground loops in any case.

What are isolated ground receptacles ?

NOTE: The following description describes isolated ground as defined in USA wiring system. In other countries "isolated ground" can mean different things (for example real ground but not connected to the power ground bar).

Many new buildings in USA are equipped with "[Isolated ground](#)" receptacles. These are normally recognizable because they are bright orange and have a triangle marked on the face. Basically, these receptacles have a separate "green wire" equipment ground, and the wire goes back directly to the circuit breaker panel, without being connected to anything else. Isolated ground receptacles are installed in the hope that electrical noise generated in the building, or by other pieces of equipment, will not disturb the operation of delicate computer equipment plugged into them.

As far as what the NEC allows, an isolated ground is a grounding connection which is grounded only at the separately derived system from which the circuit is supplied. It is permitted to pass through panelboards, junction boxes, etc. without being bonded to the equipment grounding conductor which serves those devices, thus minimizing electromagnetic interference. It must be used in conjunction with an isolated grounding receptacle to be effective. More details of isolated ground can be found at NEC 250-74 Exc #4.

My understanding on using a term "isolated ground" is mostly for marketing purposes. I feel that their purpose is a marketing response to inadequate design by some electronic equipment manufacturers and to inadequate grounding practices by some electricians. The ground terminal is isolated from the mounting yoke; in conventional receptacles the yoke and the ground terminal are connected. The "idea" is that the electrician connects a special "clean" ground to the ground terminal, while the yoke and all other non-energized metallic parts are connected to the "dirty" equipment ground.

How to avoid ground loop problems

Most electronic equipment is sensitive to ground loops and ground-induced noise. A proper earth ground at the building services entrance is the first step to avoiding such problems. In many cases, a proper earth ground is provided by a connection to the steel rebar in the building's foundation.

All outside service grounds must be solidly connected to this ground point, including power, telephone and cable television. For lightning protection, any antenna masts should be grounded here as well. Ground connection points from the telephone system controller, security alarm panel, audio equipment and other electronics gear should be connected to this ground buss. All distribution of 3 phase voltage inside of building should be done using 5 wire system. Distribution of 1 phase power should be done using 3 wire system. The safety ground wires should be interconnected in star or tree like fashion. For more information check [Residential Wiring and Grounding Guidelines](#) from [Power Clinic](#).

If possible, all electronics and computer equipment should have a separate isolated electrical subpanel with isolated ground receptacles provided at all locations remote from the main. Isolated ground means that the ground wiring is otherwise isolated from all other wiring except that it is connected to the main grounding bar for one single point. This practice will ensure that all electronic equipment grounds are at the exact same electrical potential and avoid the "minute differences" in grounds that cause ground loops. These differences are reflected in signal-carrying conductors or shields between the components and may be amplified to audible or visible levels.

Components that cannot have "equal-potential" grounds should have signals that are isolated from each other. This can be expensive and difficult to achieve. It is much easier to prevent the problems in the first place when designing the electrical distribution. More information on that is available from [Equitech](#) articles: [Power Management in the Studio](#), [Audio Wiring and Grounding](#), [1996 National Electrical Code Technical Support Bulletin](#) and [Installing a Technical Grounding System](#). Those articles provide you understanding how to make good grounding system for studio.

Do not try to modify your electrical wiring yourself. When you know what needs to be done call professionals to do the job properly (you might need a special consultant to do the plans for modifications because standard electricians don't usually know all the special requirements audio studio has). When you have proper grounding system in your studio then you can start doing the the audio wiring in a right way. You can easily easily make your system very sensitive to power system noise if you do not do the wiring properly. [Rane](#) application note [Sound System Interconnections](#) gives you good understanding how the audio connections should be done.

The problem is that in many cases you don't have possibility to change the electrical distribution system already in the place, because it will come hard to do and expensive. Then you have to live with what you get and try to solve those problems with suitable isolation devices.

[Tomi Engdahl](#) <Tomi.Engdahl@iki.fi>

Example systems with and without ground loop problems

Examples of hum-free systems without ground connection

- Typical home stereo system where all components have ungrounded (two pin) mains connectors. If the system has radio it uses the built-in antenna or short piece of wire as antenna.

Examples of hum-free systems with one ground connection

- Typical home stereo system where all components have ungrounded (two pin) mains connectors. The radio receiver is connected to the antenna connector in the wall.
- Typical home stereo system where all components have ungrounded (two pin) mains connectors. The stereo system is connected to PC soundcard (PC has grounded power connector).
- Typical home theatre system where all components have ungrounded (two pin) mains connector. The ground connection is formed through TV and VCR which are connected cable TV feed.
- Stereo system is mostly built using components which have ungrounded power connectors. One system component has grounded power connector.

Examples of systems with multiple ground connections but are usually hum free

- Small home studio system which consists of grounded and ungrounded equipments which are located near each other. All equipments are powered from one power outlet using multiple output grounded extension power cord. The system has lots of ground loops but they are very small and they don't have any current flowing in them unless there is strong changing magnetic field near the system.
- Typical home theatre system with TV, VCR and radio receiver all connected to the mains antenna outlet. The system components have all ungrounded (2 pin) power connectors. The ground loop is formed through antenna wires but the loop is small and there is normally no current flowing in those wires so no humming problems are expected unless there is strong magnetic fields nearby. If there is magnetic fields nearby then the problems can be reduced by keeping antenna and audio cables near each other.

Example systems with two ground connections and potential ground loop humming problems

- Typical home stereo system where all components have ungrounded (two pin) mains connectors. The stereo system is connected to PC soundcard (PC has grounded power connector) and the receiver is connected to the wall antenna connector. Problematic ground loop is formed by the connection between the ground pin in PC mains connector and the antenna connector shield in the wall.
- Typical home theatre system where all components have ungrounded (two pin) mains connector. The ground connection is formed through TV and VCR which are connected cable TV feed.
- Typical home theatre system where all components have ungrounded (two pin) mains connector. The ground connection is formed through TV and VCR which are connected cable TV feed and through PC connected to system.
- The audio system has two or more equipments which have grounded power connector and which are connected to different power outlets.

How the signal cable grounding is done in typical AV equipments

Grounding of case

The equipments which have metal case have typically grounded power connectors. In this case the metal enclosure is grounded to the ground of mains input.

There are some equipments with metal cases and power connector which is not grounded. In those cases the the metal case is "floating" (not connected to ground). This arrangement is possible and safe if everything inside the equipment is double insulated. Most modern Hifi equipments belong to this category.

Grounding of audio connectors

The unbalanced audio inputs and outputs have their ground side of the connector wire to audio ground, which is typically connected to metal case of the equipment (because the connector are typically mounted on metal case without isolation between case and connector). In those cases the audio ground gets connected to mains input ground if the equipment has a grounded power connector in it. This is the "de facto industry standard" to do the signal wire grounding and you have to live with it.

If the connectors are balanced, then the connector grounds are typically connected to equipment central grounding point which is connected to mains ground (professional audio equipments are typically grounded).

Video inputs

Video inputs are unbalanced connectors. Their ground is typically connected to equipment metal case and video circuitry ground of the equipment. If the equipment has a grounded power connector, then those video inputs get grounded to mains ground.

Antenna connectors

The most commonly in receivers and VCRs then ground of the antenna input is connected to equipment metal case. This means that if an ungrounded equipment is connecte to grounded antenna network the equipment gets grounded through the antenna cable.

Mains connections

3 phase distribution

The most common way to distribute high power to building is 3 phase system. That 3 phases system has advantages that it saves wiring copper and is very suitable for driving powerful electric motors. The wiring is designed so that it need that the power taken from each phase should be about equal. This is done by connecting all high power loads to all three phases and distributing all smaller loads eventually to those three phases.

Three phase power has three "hot" wires, 120 degrees out of phase with each other. These are usually used for large motors because it is more "efficient", provides a bit more starting torque, and because the motors are simpler and hence cheaper. The 3 phase wiring is usually used in electrical distribution because the power can be carried with a little bit less copper than with single phase distribution (especially when the load is well balanced).

The power comes from the power company through 4 current carrying wires: 3 phase wires and neutral wire. If the current is exactly matched in all phases, there is no current flowing in neutral wire. The neutral wire is connected to the building ground in the central mains distribution panel where is the building main grounding bar.

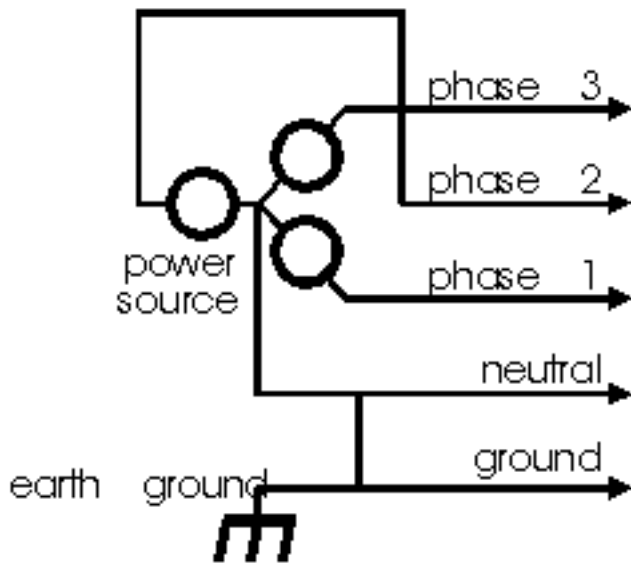

From the main central distribution panel there goes 5 wires to the subpanels. 4 current carrying wires are 3 phase wires and neutral wires. Safety ground is a separate wire which also goes to the central grounding bar like neutral wire. The difference of neutral and safety ground wires is that neutral wire does carry current in normal operation (the difference of currents taken from each phase) but safety ground does not carry any current in normal operations. This separation guarantees that in normal operation the whole safety ground wire is in building ground potential. This 5 wire wiring system is basically good and it is used in most buildings and places where ground loops are expected to be a problem.

All distribution of 3 phase voltage inside of building should be done using 5 wire system to avoid grounding potential difference problems. Distribution of 1 phase power should be done using 3 wire system. The safety ground wires should be interconnected in star or tree like fashion.

Three phase distribution in Europe

Three phase distribution is a very common in big houses (offices, shops, factories etc.) where lots of power is consumed and big motors are quite probably presents. In Finland and many other countries 3 phase distribution (230V from phase to ground and 400V from phase to phase) is very common in even smaller houses (typical house in Finland has 3x25A three phase main feed).

Three phase power most often used in permanently wired electrical equipments like electrical ovens and large motors. In normal residential homes there are no normally any power outlets for 3 phase power. In places where there is need to power equipments which consume more power than what is available from one mains outlet, there are usually 3 phase connectors available. Examples of this kind of places are construction sites, factories, places where large electrical tools are used and entertainment venues (for large PA system and lights). The most common 3 phase outlet you might to see is 16 ampere 3 phase 400V (voltage between phases) outlet which uses round red CEE 17 connector. Other popular models of this same round red connector can handle 32A, 63A and 125A.

Three phase distribution in USA

You're most likely to encounter a 3 phase circuit that shows 110 volts between any hot and ground, and 208 volts between any two hots. Those 3 phase distributions are commonly used in place where there are large motors or otherwise much consumption of electricity. Examples of this kind of places are factories, big shops, large office houses and similar buildings.

Getting a 3 phase feed to your home house in USA can be ridiculously expensive or impossible. Residential houses are typically wired using "normal 220/110 wiring" where there are two 110V live wires (180 degrees in phase with each other) and they share a common neutral wire. Normal electrical outlets are wires between one 110V live wire and the common neutral wire. Some high current loads (air conditioning etc.) are wired between two phase wires so they get full 220V voltage.

Grounded outlets

While you may initially assume the three pronged cords to be inherently better, due to their ability to introduce multiple grounds to the audio system, they actually serve to further complicate the ground looping problems. Three pronged grounded outlets are better for electrical safety. Grounded outlets they are also good when the electrical distribution and audio wiring is well designed and constructed.

The 3-wire system that the user sees is actually derived from three phase distribution, which uses a 5-wire system. In the 5-wire system, there are 3 hot wires, 1 neutral wire, and 1 grounding wire. The common 3-wire receptacle uses only one of the 3 hot wires.

A typical office wall outlet has three electrical connections, which are the "hot", "neutral", and "grounding" wires. All office equipment requires only the hot and neutral wires to function. The third or grounding wire is connected to exposed metal parts on the equipment. Within the building, the grounding connections of all electrical receptacles are wired to one another and are connected to the water piping. This ensures that all electrical equipment with exposed metal parts has these parts electrically connected to each other and to exposed metal fixtures in the building such as water fixtures.

The hot and neutral wires are interchangeable as far as the equipment is concerned. Both are power carrying wires. One of the power carrying wires is grounded for reasons of safety.

Grounded equipments

Grounded equipment wired from mains voltage has three wires going to the equipment: live, neutral and ground. Live wire is one of the the phase wires from the 3 phase distribution systems. Neutral and ground wires are the same as in 3 phase distribution systems. The equipment load is connected between the live and neutral wires like in the picture below:

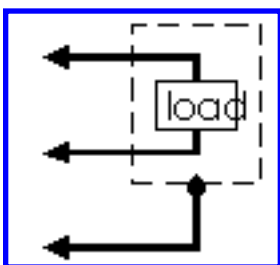

Here the two upper wires are the live and neutral wires. There is not much difference which one of those is live and which one is neutral because modern equipments are designed so that this does not matter. In some countries the power connector is designed so that you always know which wire has live and which has neutral in it. In some countries (for example Finland) the power connector is designed so that it can be put to the connector in two ways.

The third wire (the lowest one) is the ground wire. The ground wire goes to the equipment metal case and is there for giving safety to the user. When the metal case is tightly connected to the ground through the grounding wire then if there is something wrong in the equipment (like broken insulator or water leaks inside equipment) you just blow the fuse instead of getting lethal voltage to the case.

Grounding system is carefully designed so that it provides safety to the user. This includes the color coding that the safety ground wire is never mixed with any other wire (nowadays the safety ground wire must be always yellow-green colored in Europe). The electrical connectors must be designed so that the safety ground connects before other pins and disconnects last. When wiring the safety ground wire to connectors the wire to it must be a little bit longer than what goes to other pins so that if the cable gets loose it is the last one which loses the connection,

Connectors used in grounded equipments

USA mains connector

The power supply cord used on most modern electronic equipment has a three pin plug (NEMA 5-15). The connector has place for two flat power pins for live and neutral wires and third round pin is ground. Typical mains receptacle in wall in USA nowadays is a grounded 15A power outlet. A correctly installed receptacle should always be vertical with the ground pin beneath the two parallel blade slots.



There is also a 20A version of the mains connector which is used in some heavy equipments where 15A of 120V power is not enough.

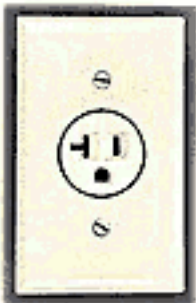

Many new buildings in USA are equipped with "Isolated ground" receptacles. These are normally recognizable because they are bright orange and have a triangle marked on the face. Basically, these receptacles have a separate "green wire" equipment ground, and the wire goes back directly to the circuit breaker panel, without being connected to anything else. Isolated ground receptacles are installed in the hope that electrical noise generated in the building, or by other pieces of equipment, will not disturb the operation of delicate computer equipment plugged into them.

The black (hot) wire goes to the brass or copper screw which is connected to the right (smaller) slot The white (neutral) wire goes to the silver or chrome screw which is connected to the left (larger) slot. The bare wire(ground) goes to the green screw for the separate ground path. These connections should always be made by a qualified electrician!

IEC connector

IEC connector is a standard international mains connector used in equipments like computers, printers, fax machines and many other grounded equipments which have removable power cord. The same connector is used in both 120V and 230V equipments. The connector can handle voltages up to 250V and current up to 10A.

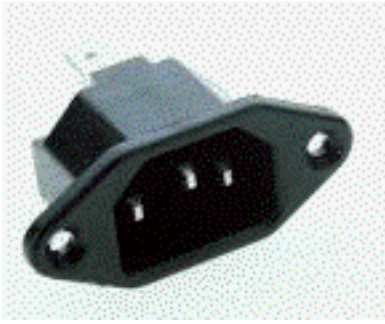

SCHUKO

Finland, Sweden, Germany and many other European countries use a SCHUKO mains connector (CEE 7/7) in grounded equipments. The connector provides two pins for carrying live and neutral wires (current up to 16 A).



The grounding is most commonly done using the small bare metal parts on the sides on the the connector (you can see one near the pace where the wire leaves and another on the the opposite side). There is also a hole for a separate grounding pin used in some countries.

UK style grounded mains connector

Maybe the most common electrical outlet used around the world is the UK style 3 pin mains connector (BS 1363). That connector is used in UK, Ireland and most of the countries which were once part of the British imperium. This makes this mains connector maybe the plug which is used in most countries.



This connector is designed so that it can be only fitted in the wall in one way so it is always know which pin is which. The totally metal pin (up in the picture) is the ground pin. Those pins which have part of them insulated are the live and neutral pins. The speciality in the wiring used in UK is that there is a fuse placed inside the mains plug. The size of that fuse is to protect the equipment wire from overheating in case of short circuit (fuse size is determined by the equipment wire size) because the main fuse which powers many electrical outlets is typically quite large (up to 30A). The maximum current which can be taken from one outlet is 13A.

Ungrounded equipments

Many small home electronics and light equipments designed for use inside house do not use grounding. Those equipments are built using double

insulation or insulating case so that danger of electric shock is prevented in this way. Ungrounded power connection needs only live and neutral wires.

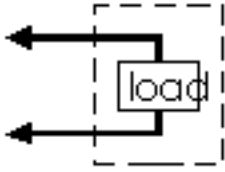

Connectors used in ungrounded equipments

The most common connector in small electronics in Europe is so called EURO connector and is standardized in EN 50 075. This connector is designed so that it can be used in most parts of Europe. EURO mains connectors can typically handle only 2.5 amperes of current. Typically the connector is a molded plug which is permanently connected to the cable and the plug can only be bought with the cable included.

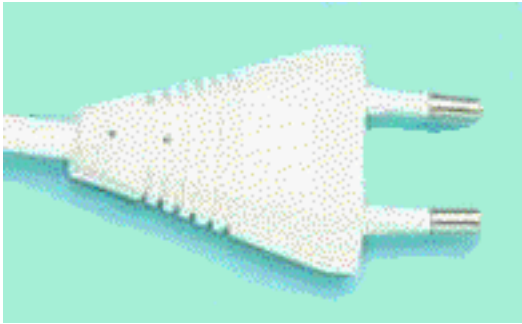

Mains plug used in USA

Ungrounded plug is quite commonly used in small light and home electronics like TVs, VCRs etc.

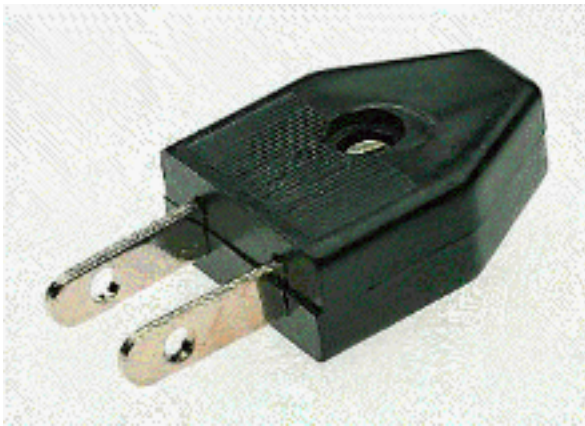

Nowadays, many two-prong devices have one prong wider than the other. This is so that the device could rely (not guaranteed!) on one specific wire being neutral, and the other hot. This is particularly advantageous in light fixtures, where the the shell should neutral (safety), or other devices which want to have an approximate ground reference (ie: some radios).

Many television and stereo components as well as appliances are being fitted with polarized plugs which have a wider spade for the neutral line cord wire. In some equipments a "bypass capacitor" which is wired between the white (neutral) wire and the equipment chassis ground. Capacitor offers a relatively low impedance to high frequencies (such as generated by radio stations and CB. radios) thereby providing them with a "short path" to ground in order to eliminate this type of interference and offers a high impedance to low frequencies (not much mains current passes through it so there is no significant shock hazard). Neutral wire is not very good ground in radio frequencies so this connection might cause more problems than it solves. Sometimes the coupling capacitor from the neutral to the case can be up to 0.1 uF and if the neutral and live are for some reason swapped you can get over 4 mA of current flowing to the equipment case. This kind of arrangement that live and neutral wires are handled differently inside equipments has not been recommended by international safety regulations for long time but it has been allowed practice in USA.

If you determine that you have a hot chassis with a system connected like this the solution is to simply reverse the plug (if you can can). Reversing

the plug can sometimes solve interference problems. In some instances in transformerless consumer receivers where the case was connected to the neutral side of a polarized a-c plug via a 0.1 uf capacitor. Since at the mains the neutral is grounded, there may develop a small potential between the amp case and (extended) mains ground. If there is any heavy power draw in the vicinity of the same circuit, the potential may increase if wiring conductivity has decayed for various reasons.

[Tomi Engdahl](mailto:Tomi.Engdahl@iki.fi) <Tomi.Engdahl@iki.fi>

Published by ELH Communications Ltd. all rights reserved.

Naming Electricity System Earthing Arrangements

The information on this document is based on [UK DIY FAQ](#) part written by Andrew Gabriel.

European naming conventions

Mains electricity systems are categorised in the many European countries (Finland, UK, etc.) according to how the earthing is implemented. The common ones are TN-S, TN-C-S and TT.

Note that in these descriptions, 'system' includes both the supply and the installation, and 'live parts' includes the neutral conductor.

Description of letters

First letter:

- T The live parts in the system have one or more direct connections to earth.
- I The live parts in the system have no connection to earth, or are connected only through a high impedance.

Second letter:

- T All exposed conductive parts are connected via your earth conductors to a local ground connection.
- N All exposed conductive parts are connected via your earth conductors to the earth provided by the supplier.

Remaining letter(s):

- C Combined neutral and protective earth functions (same conductor).
- S Separate neutral and protective earth functions (separate conductors).

Valid system types in the 16th Edition IEE regs:

- TN-C No separate earth conductors anywhere - neutral used as earth throughout supply and installation (never seen this).
- TN-S Probably most common, with supplier providing a separate earth conductor back to the substation.
- TN-C-S [Protective Multiple Earthing] Supply combines neutral and earth, but they are separated out in the installation.
- TT No earth provided by supplier; installation requires own earth rod (common with overhead supply lines).
- IT Supply is e.g. portable generator with no earth connection, installation supplies own earth rod.

Ways to provide grounding

Inside or nearby your consumer unit (fuse box) will be your main earthing terminal where all the earth conductors from your final subcircuits and service bonding are joined. This is then connected via the 'earthing conductor' to a real earth somehow. The following earthing conventions are used in UK:

- TN-S The earthing conductor is connected to separate earth provided by the electricity supplier. This is most commonly done by having an earthing clamp connected to the sheath of the supply cable.
- TN-C-S The earthing conductor is connected to the supplier's neutral. This shows up as the earthing conductor going onto the connection block with the neutral conductor of the supplier's meter tails. Often you will see a label warning about "Protective Multiple Earthing Installation - Do Not Interfere with Earth Connections" but this is not always present.
- TT The earthing conductor goes to (one or more) earth rods, one of them possibly via an old Voltage Operated ELCB (which are no longer used on new supplies).

There are probably other arrangements for these systems too. Also, a system may have been converted, e.g. an old TT system might have been converted to TN-S or TN-C-S but the old earth rod was not disconnected.

Solving the humming problems of computer soundcards and home theatre systems

Getting rid of ground loops is not easy. Finding them is even harder. [LiveDV magazine](#) has published a good tutorial Soundings: Getting Wired (January 1996) how to find and solve ground loop problems in typical home AV system which consists of computer and other AV equipment (receiver, amplifier, VCR etc.).

The only acceptable method for testing is to remove and disconnect everything. Then reinstall the equipments and connection piece by piece. Stop when the hum becomes audible, and fix the problem in the last piece of equipment that was installed.

If you have equipments connected to many power outlets, then try to connect them all to one grounded extension cord and then plug this cord to one grounded outlet. This solves usually many problems, because this creates star-like grounding scheme for those equipments.

But the following star grounding scheme is effective if the equipments do not have any direct connection to other equipment grounded elsewhere (transformer isolated connections are ok).

Computer soundcard problems

Typical computer soundcard ground loop situation

Typical ground loop humming problem occurs when you connect your computer sound card to a stereo receiver which is connected to wall antenna plug. The computer is connected to grounded power outlet which causes that the sound card audio ground is connected to mains ground. The receiver gets connected to antenna ground because it is wired to the antenna plug in the wall. The mains ground and antenna are tied together (or at least should have) somewhere else in the house. Unfortunately there is all kinds of electric interference which can be coupled to those grounding wires and cause small potential differences between the ground on the antenna outlet and your mains outlet. The small potential difference causes small current flowing through the equipments and cables which causes hum to them.

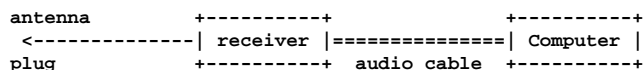

If you want to get rid of this annoying humming problem then first remove the antenna connection of your receiver. If removing antenna cable helps to get rid of humming then get an [antenna isolator](#) to the antenna connection of your receiver or an [audio isolator](#) to the audio cable between your computer and the receiver.

Typical computer audio problem case

I have my computer soundcard connected to my HiFi system. I connected my TV to my AV receiver and I get very loud buzzing even if the TV is off. Same also happens if I connect my VCR to the AV receiver.

I decided to go through the routine ground-loop check by disconnecting everything and putting everything back together. The check gave following conclusions:

- When I only disconnect my computer's power cord (3 prong) the buzz goes away.
- When I only disconnect the soundcard from my receiver the buzz goes away.
- When I disconnect my TV and VCR the noise goes away

Basically, the hum/buzz goes away when any of the following altered:

- 1. Sound Card disconnect (from receiver)
- 2. Computer unplug (from power strip)
- 3. TV disconnect (from receiver)
- 4. Cable TV disconnect (from wall)

How the isolators can be used to solve the problem

The most effective way to stop this 50 Hz or 60 Hz noise is to break the galvanic connection which causes the ground loop. You can either connect an [isolator to the antenna wire](#):

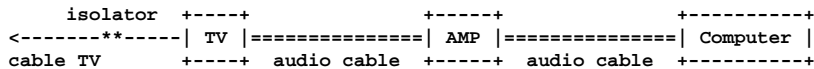

or putting on [isolator to the audio line](#):

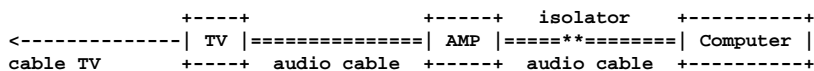

This is the only effective and safe solution to problems which deal with grounded outlets and radio/TV cable/antenna connection.

TV and audio system

If you connect your TV or VCR to otherwise humless audio system you will quit epropably hear a humming noise (50 Hz or 60 Hz depending on the mains voltage frequency) caused by current flowing between your equipment and the antenna connection in the TV. The following example is a typical home setup where you have your multimedia computer TV and connected to your stereo system:

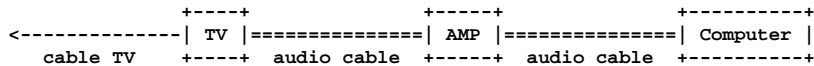

Most people have their surround sound receiver connected to a "home entertainment center" with at least a TV and cable. If this is the case, try disconnecting the cable. If your stereo system has also a receiver which is connected to wall antenna plug then remove it also because the receiver antenna connection can also be a source of humming. If removing antenna cable helps to get rid of humming then get an [antenna isolator](#) to all your antenna connections or an [audio isolator](#) to the audio cable between your computer and the amplifier.

PC based DVD systems

PC is becoming a more and more popular signal source for a home AV system. Nowadays when many new PCs are equipped with DVD drives and display cards with TV outputs, so increasing number of people have started to connect their PCs to their home theater systems.

If you are using one ground for your PC system and a different one for your cableTV service then you most likely have Cable TV ground loop. This can be witnessed as an audible hum through your speakers or vertical black bars on a video display.

There are two remedies to correct this problem. The first is to use the same ground for both the Cable TV and A/V system. Unfortunately chanign the grounding of those you well need an electrical and a cable TV installation people. Better grounding practices usually reduce the problem, but quite often does not solve it completely.

The second and usually more viable option is to install high impedance isolation between the the cable TV conductor and the A/V system and the cable TV shield and the A/V system. And the right adapter for this is the same [isolator to the antenna wire](#) discussed eariler on this document. This method is usually the most effective and is the most inexpensive solution. The picture below shows one possible interconnection of PC with DVD drive, AV amplifier and a TV:

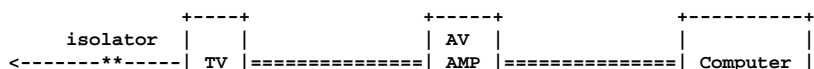



```

cable TV      +-----+ video cable +-----+ audio cables +-----+
                                     video cable

```

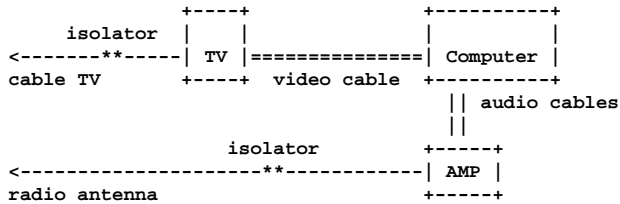
Here is another quite propable configuration you might encounter. This is an example of properly wired system with a TV and an amplidifier with a tuner and both wired to the antenna connection on the wall:



As you can see, you need two antenna isolators for this case. One for TV input (for solving video humming bars problem) and another for tuner antenna connection (for solving audio humming).

Audio+video and computer systems with many grounded equipments

Even if you have multiple mains sockets in your room, to take the power for everything from a single socket (run it through a mains filter if you want), then connect everything to that as a tree. Sometimes buildings are wired with a lot of electrical distance between the separate sockets in one room, so this trick can avoid many problems. If this doesn't work, call in an electrician to make sure that your buildings earth actually works at all - you could be risking your life otherwise.

Tips for building well working systems

As with any project, planning can have adirect effect on the results. Before you start setting everything up you should decide where your equipment will be placed. Now, determine where to run the cables. For initial testing connect all of your components and run your cables across the floor, out in the open. Once you are satisfied with the way everything is setup, make sure everything is working properly. ou are now ready to permanently install the system and run the cables. Run the cables in the predetermined locations being aware of electrical and coax anteenaa wiring. Do not run your audio cables parrallel to these types of cables, because they tend usually be quite strong noise sources for audio cables.

When making connections use the established color coding system for consumer electronics. White is left, Red is Right and yellow is video. When running cables thru walls make sure you use cable types approved for permanent installation.

I have found that it is essential to keep a flashlight handy and work with a second person. You should keep in mind that properly installing and setting up your equipment is just as important as selecting it. Spend a little time planning your system and installation will save time and money.

Multiple room systems

Depending on your local electric wiring regulations, the potential of the ground terminal in the wall outlets will be slightly different in different rooms due to other loads in the building and the potential will also be different than at a grounded antenna or CATV feed. The voltage difference is small, usually about 1 V.

If you have grounded equipment (either through the wall outlet or through the antenna system) in different rooms and you connect an unbalanced cable directly between the equipment, a large current (up to several amperes) will flow in the shield and it still can not completely remove the voltage difference between the rooms and you have hum added to the signal. When this ground loop current flows in the shield, it will also induce some hum current into the signal lead, worsening the situation even further.

So if you are running signals from one room to another it is a very good idea to isolate all the unbalaced connections using suitable audio isolation transformer. Other possibility to get rid of that problem is to use baöanced interconnections if your equipments have such (those are uually only available on professional audio systems equipments).

Other than ground loop sources for humming

Not all humming and noise is caused by ground loops. There are lots of other interference sources which can cause humming and other kinds of noise. An earth loop will typically inject a 50Hz or 60Hz hum into the signal cables. There can be also exist other harmonic frequencies in ground loop soiation, but practically always there is that 50 Hz or 60 Hz strongly around.

if you have a 100Hz or 120Hz hum (which often has a hard "edge" to the sound) without that lower frequency 50Hz or 60Hz around, you should definately check also other sources of interference. Possible causes for this kind of only higher frequency interference is something wrong in the wiring of the power supply or some noise source in the electrical power system which causes that harmonic noise (light dimmer for example).

I am getting a lot of hum and hiss from my system. Is there a quick way to tell if the amplifier is making the noise, or is it a problem with my system?

The fastest way to tell if the amplifier is the cause of the noise, is to disconnect the input cables from the amplifier. If the noise is still there, it may be amplifier; if it's gone, it's a source device inducing noise into the amplifier. If after removing the input connectors from the amplifier you find the noise still present, it will then be necessary to determine if the noise is coming from the AC line. This further isolation may be helpful. Try relocating the amplifier using a different AC service, if the same level of noise is present, the amplifier is likely to be the cause. If the noise is lower, the AC service may be the cause.

Magnetic fields from transformers can cause humming

Mains transformers typically cause an AC magnetic field around them. This magnetic field can be copled to wiring, electronics or signal transformers and cause humming. Typically audio electronics are designed so that the magnetic felds caused by the mains transformer are not coupled to the sensitive elctronics in the equipment, but the magnetic fields from other equipments can be coupled to the electronics.

If you have many equipments which have transformers inside them stacked together then you have a risk that the magnetic field form other equipment's transformers can cause hummign to the other equipments. The normal aluminium case does not provide much protection against low frequency magnetic fields and only steel case can shield agains magnetic fields. Some power transformers in powerful equipments (like amplifier) are leaking a pretty heavy magnetic field. This has something to do with it being cheaply constructed without good core material and something to do with the design configuration. Leaving a couple blank spaces between the equipment with that leaky power transformer and anything else might help. You can also try moving things around so the units that are least suceptable to hum pickup are closest to humming source.

Many equipments nowadays use small wallwarts which you plut go wall socket. Those transformers are usually chapely built (like those cheapest universal adaptors) and can cause lots of magnetic fields around them. It is not advisable to put any sensitive signal wires or equipments near those wall transformers because they can cause serious humming problems. Look around and leave adequate space between the gear with transformers inside of them.

Magnetic fields induced from other wires

Hign current carrying mains wiring can cause quite strong magnetic fields around the cable. If you run an audio cable near high current mains wiring it can easily pick up humming. It is a good idea to keep at least 0.5 meter distance between high current mains wiring and your audio cabling. If the audio cable must cross a mains cable then make this crossing at exactly 90 degree angle so the mains cable magnetic field will not be coupled to audio cable.

The interference coupled from mains wiring can become especially noticable if there are some problematic loads like fluorescent lighting, light dimmers or lots of computers connected to the mains wiring.

Magnetic fields from distribution panels

Main power distribution panels have high current carrying wires, relays and contactors in them and they can cause quite strong magnetic fields around them. It is not advisable to put any computer monitors or audio equipments near them. Few meters clearance from mains distribution panel is usually enough to stop any magnetic interference.

Magnetic fields from electrical motors

Electrical motors use strong magnetic fields inside them, so typically those motors also cause a noticeable magnetic field around the motor. If your equipments are near some powerful electric motors you might have quite strong magnetic fields near your equipments. Remember also that fans used in air conditioning and in many equipments can generate problematic magnetic fields so it is a good idea to keep your equipment away from those.

Radio interference

Radio interference can cause serious noise problems to the audio system which is not properly shielded. The most typical noises are all kinds of interference noises and the transmission is heard in the audio system. Some strong radio transmitters and industrial systems which use radio frequency signals can sometimes be modulated with mains frequency humming (for example because of poor power supply). If this kind of modulated radio frequency signal enters to your equipments it can cause mains hum like interference which is very hard to get rid of.

Main voltage quality problems

If mains voltage is not nice sine wave then it contains harmonics which can usually more easily enter to the circuit than 50 Hz mains. Typical sources for this kind of power quality problems are high frequency interference caused by dimmers. Computer power supplies and fluorescent lighting can cause harmonics to the power and thus interference to sensitive equipments. Some cheapest UPS equipments put out very low quality main voltage and if you connect sensitive audio equipments to such UPS you can get all kinds of noise problems.

Mains quality problems are usually solved by using mains filters and isolation transformer. Many professional studios used high quality on-line UPS equipments to power the whole studio. This UPS will filter out any problems from the incoming power and also useful protection against short mains power breaks.

Sources for hissing noise

Sometimes the humming in the audio system is not the main problem, but the hissing like noise. Here are few noise sources and how to avoid that noise.

First and foremost there's what is called "thermal noise". It is generated by all active and passive electronic components (including cold solder joints) and is simply a result of all those un-cooperative electrons smashing each other. The only way to avoid the thermal noise in components is to make them very cold, but this is not an option in audio electronics. The gain structure of your system becomes an important to get maximum signal/noise ratio.

Radio frequency interference (RFI) is a big source of all kinds of noises. Many RFI interferences are easily undetected if you can't hear the actual "radio signal". Radio interference can easily take the form of hash that sounds like white noise. Proper grounding and shielding practices are your only real defence against RFI.

Digital noise usually takes a form of high-pitched whine (usually around 15 kHz or so), but at low levels can be mistaken for hiss. Digital keyboards, lighting, computers, effect processors and just about everything which uses fast clock pulses can cause this problem. This includes the switched power supplies in many modern audio equipments and some amplifiers. Some poorly designed equipments can radiate excessive levels of digital noise, often via mains AC cord. Carefully routing the AC power cords and audio cables away from each other can help to avoid this problem. Digital noise can also be in the form of radio frequency interference, so do not place a wireless microphone receiver near digital effect units and computers.

An electronics component which is failing can be a source of noise. You can identify this hiss because it is not consistent. It will vary fairly rapidly, depending on run time and temperature. The noise can also be "popping" noises, similar to popcorn. To get rid of the problem locate the bad part/equipment and get it replaced or repaired.

One problem is the poorly designed equipments. Some companies use active components with poor noise performance. You can get rid of this kind of problem by replacing the nasty components or the whole equipment. If you must use the existing equipments as it is then careful gain structure adjustment can usually keep the noise at acceptable levels.

[Tomi Engdahl](mailto:Tomi.Engdahl@iki.fi) <Tomi.Engdahl@iki.fi>

Published by ELH Communications Ltd. all rights reserved.

Why do you have to use a separated conductor for grounding and for neutral?

General information

There are multiple reasons why modern electrical wiring is done so that there are separate wires for neutral and ground. Two most important reasons are the following:

1. Safety

When there are separate wires for neutral and ground it is much less likely that a problem in electrical wiring causes a dangerous situation which will cause electrical shock or fire.

If the ground and neutral were the same conductor, the cutting only the neutral wire (for example by accident) would cause the grounded metal case of the equipment to be on mains potential just because there is only live connected to equipment and that voltage can go through the equipment to the cut neutral cable and from there to equipment case.

When ground and neutral are separate, then cut neutral causes only the equipment to stop working and no dangerous situation. If ground gets cut by accident, there is no danger caused before some equipment gets damaged. So when there is separate wires for neutral and ground, a single wire fault (cut or short circuit to other wire) on any wire going to outlet does not cause immediate danger to the user of the equipment:

- Live shorted to ground or neutral: fuse blows immediatly. When fuse is blown then the dangers of electricity are gone.
- Neutral shorted to ground: No immediate danger to use, just nasty ground loop problems start to occur. If there is GFCI or other ground leakage detector in wiring, it will cut the power to the outlet.
- Live or neutral cut: Equipment just stops getting the power
- Ground wire cut: The safety ground to equipment is lost. It continues to work nicely and there is no danger as long as there is no fault inside the equipment. Potentially as dangerous situation as using ungrounded outlet in same place, but no immediate danger.

So any single failure does not cause great danger. So the for safety sense separate ground and neutral wires are a very good idea.

2. Minimizing the ground potential differences between outlet grounds

In an ideal separate grounding wire system there is no current flowing in ground wire network, so there is no voltage difference between grounds on different outlets. Unfortunately in real life systems there is always some current leakign to ground, but that current is very small (only propably milliamperes) compared to the current flowing on line and neutral wires (usually amperes).

If the neutral and ground were shared on same wire, the current flowing on neutral wire would easily cause a large voltage difference (up to many volts) on different outlets grounds. The ground potential on any outlet will then depend on the load current, neutral wire resistance and the mains phase it is connected to.

Conclusion

For the conclusion we can say that separate ground and neutral conductors are a very good thing in providing good electrical wiring security and minimizing ground potential difference between different outlets. So it is no wonder why modern electrical wiring regulations call for this arrangement in many applictions.

If the neutral to ground difference a problem when separate wires are used ?

In large computers, neutral to ground voltages are originated because nonlinear currents flow through the neutral wire. In general always when there is some current flowing in neutral wire, there will be a ground to neutral wire voltage difference on output end, because there is no current flowing on ground wire. In some computer systems the voltage differences are considered to be a problem, because it has been reported to cause improper behaviour like "hangouts" on some computer systems.

It is true that in some special cases neutral to ground voltages can cause this kind of problems, but in those cases it is not to blame the separate wires, because the problem lies in some other place. In properly built electrical wiring network, the neutral to ground voltage differences will never be more than few volts and any properly designed electrical equipment should not be disturbed by this kind of small voltage differences.

If the equipment gets disturbed by this small main frequency voltage, claim the manufacturer/designer of that particular equipment for doing a bad job. Computer equipments can be easily designed to cope with few volts of voltage differences between neutral and ground. Most of the modern equipments are designed to cope with this.

If the voltage difference between your neutral and ground is much larger than few volts or there is very good probability that there is something wrong on your main wiring. So it is best that an electrician goes and checks your wiring before more problems and damages happen.

In some cases the neutral actual to ground voltage is not the problem, but the waveform of the voltage. Non-linear loads like computer power supplies and light dimmers can cause some considerable noise between neutral and ground. Such noise can be more problematic than just a simple voltage difference, but equipment should still be able to cope with a fair amount of it (EMC regulations etc.). If you have considerable amounts of noise on neutral wire used by nonlinear loads, then you can again blame the improper design of the electrical wiring. This kind of problems can be solved by good wiring design practices: separate electrical wiring from main panel/transformer to the equipments which cause noise and to equipments which are sensitive to it. This is good practice and keeps problems away.

If you would have on those cases had a wiring with common neutral and ground wire, you would have terrible ground potential differences between different outlets. In cases where there are problems with neutral to ground voltage differences in separate ground and neutral wire wiring start to cause a problem, a wiring with common ground+neutral wire there would be so much ground potential difference between outlets that any equipments connected to different electrical outlets and interconnected would work very erratically, you would probably cause many equipment damages. Computer systems are generally much more sensitive to the ground potential differences than ground to neutral differences.

The bottom line is that separate ground and neutral wire is a good thing for many problems. It solves more problems than what it potentially causes. And in very rare situations where separate ground and neutral wires cause some problems, in those same situations a wiring with common neutral+ground wire would have caused much more but different kind of problems in form of ground potential differences. When taking account situation where computers are interconnected/networked, a good stable ground potential for all equipment is much more important than very small neutral to ground potential. Separate ground and neutral wires is a good method to keep the outlet grounds at same potential, which is very important in networked computer systems.

[Tomi Engdahl](mailto:Tomi.Engdahl@iki.fi) <Tomi.Engdahl@iki.fi>

Audio signal grounding in audio equipments

Grounding in consumer audio is somewhat fragile because there is no overall plan. Each piece of equipment takes a slightly different approach. As long as there are only a few units involved, there are few if any problems.

Once the system grows beyond a certain point the lack of a grounding plan catches up with the consumer and there is hum or worse. The exact point where trouble begins depends on the specific units involved and the local power and cable TV system wiring. Ideally, you want the audio system grounded at a single point.

The grounds of the input and output connectors in typical audio equipment are typically wired to common ground in the equipment. That common ground is typically connected to equipment case.

If the equipment has a grounded power connector, then the case ground is connected to mains grounding connector. If the equipment does not have the grounded power connector, that ground is not connected to mains ground (case is floating).

That is the typical case in home audio equipments and also in many professional/semiprofessional equipments. Many commercial amps use balanced inputs for hum reduction, but that is not available in home audio equipments.

With home equipments the grounding situation gets worse for audio, when equipments with grounded plugs are added to the system - as the 'ground' potential can vary through various circuits in your home. This differing 'ground' level will be impressed on the low-level signals as common-mode hum.

Usually the real trouble maker in your system is the connection to the cable TV system. The antenna connector shield is grounded typically in the equipment to same point as all the audio inputs (equipment case), but the other end of antenna cable can be grounded to the common ground with the mains ground somewhere quite far away. When there are multiple ground paths they are virtually never at the same potential and therefore some current will flow through your equipment grounds often causing the hum you are experiencing.

[Tomi Engdahl](#) <Tomi.Engdahl@iki.fi>

Why professional sound systems suffer from ground loop humming

Good and bad balanced connections

Balanced interconnection systems used in professional audio world are naturally very good at rejecting noise problems. The shield grounded on both ends of the cable to equipment cases provides a very good shields against RF interference and electric fields. The balanced nature of the signals will very effectively eliminate the effect of small potential differences between the audio equipments. The twisted nature of the wires is good at reducing the effect of noise from the magnetic field.

Because those design choices, a balanced audio interconnection should be quite much free of any ground loop problems when the whole system is done using balanced interconnections. And if there is need to connect anything unbalanced to such system, those should be connected using DI-boxes and isolation transformers. This should provide a hum free operation for equipments.

Unfortunately in real life the situation is not so simple. Many audio manufacturers, consciously or unconsciously, connect balanced cable shields (pin 1 in XLR connector, sleeve on 6.3 mm jack) to audio signal ground instead of the equipment case ground where it is supposed to be originally connected. The result of this design choice is that any currents induced into the shield modulate the ground where the shield is terminated. This also modulates the signal referenced to that ground and the result is typically annoying humming noise.

Unfortunately the practice of connecting noisy cable shields to audio ground is very widely spread. This improper arrangement of shield grounds amazingly sometimes achieves somewhat acceptable performance. It performs well in many standard audio equipment bench test, but the performance on the field can be quite much varying. This means that getting good performance from such system need quite much testing and tweaking including ground lifts and isolation transformers.

The hum and buzz problems with too many balanced equipments with signal grounded shields have given balanced equipments a bad reputation. This has created great confusion among system designers and users. Unfortunately this is the situation where we have to live in.

The truth of a balanced interconnection is that a properly designed and built balanced interconnection is very much better than any unbalanced interconnection in rejecting humming noise. Properly designed balanced interconnection means that for fully balanced operation the signal wires should be well impedance balanced and the shield of the cable should connect to the chassis ground at the point of entry.

Balanced and unbalanced interconnections

Balanced and unbalanced systems are not designed to interface together directly. In nowadays system there is unfortunately many times need to interface balanced and unbalanced equipments to each other. This kind of interfacing is always very possible source of causing unwanted humming entering to the system.

The most proper way to do balanced to unbalanced interconnection is to use an transformer isolation in the interconnections. This gives you the most reliable results. In some cases just a special cable or adaptor will do the job, but in this case you have to be very careful what you are doing to avoid humming to enter the system.

Unbalanced interconnections

Unbalanced interconnections (common in home audio) should be avoided in professional sound systems for many reasons. An unbalanced system uses only two wires, one for signal and one for ground, which arrangement has an inherent problem called common impedance coupling. If two different circuits share the same conductor or wire, a current flowing in either circuit will produce a voltage drop across the wire and that voltage drop will become summed to the signal in the cable.

Since the cable shield is effectively connecting the grounds of the devices together, it carries a current derived from the power line as well as the

audio signal current. A receiving cannot tell the difference between signal and hum, and will amplify both if they are present.

If you have a humming problem with an unbalanced connection, the choice is to somehow reduce the problem is to reduce the interchassis current. We could eliminate it by simply breaking the chassis to chassis shield connection. This is usually best done using an audio isolation transformer fitted to the line. Simply just cutting the audio cable ground wire will not stop the effects of voltage differences between equipments. On the other hand cutting the mains cable ground wire connection is potentially dangerous and against electrical safety code.

[Tomi Engdahl](mailto:Tomi.Engdahl@iki.fi) <Tomi.Engdahl@iki.fi>

Published by ELH Communications Ltd. all rights reserved.

Advice on setting up hum free safe PA system

This text is based on my personal experiences with PA systems, [RaneNote 110](#) and the advice given in **Concert Sound and Lighting Systems** book written by John Vasey (second edition, published 1993 by Focal Press). Following those simple rules I give you will avoid almost all causes of humming problems and you will save many hours for more creative work in your system setup.

Use single power feed everywhere you can

If your system power requirements allow take power only from one electrical power outlet. This will avoid the ground potential difference problem which can exist if power is taken from multiple power outlets. If the distance and electrical code permits is a good idea to run a power extension cords from your single power feed points to all subsystems connected to your audio system instead of using the local power sources.

Wire all audio equipments which you connect to mixer to same phase

Use dedicated power feed for your audio system. Wire all sound sources, musical instruments, effects and your mixing desk to same grounded dedicated audio power feed. Do not connect any other equipments than audio equipments to this power feed. This saves you from many humming problems. It is a good idea to mark clearly which extension cords are part of your audio power feed so that you don't accidentally connect any other equipments to them (it is good idea to tape over all power outlets from this audio feed which are not used by your audio system so nobody will accidentally plug any other equipments to your audio power).

Especially avoid plugging fluorescent lights, lighting dimmers, computers and video equipments (like video projectors and TVs) to your audio power feed.

Use balanced connections everywhere you can

Balanced connections are much less sensitive to pick up interferences and humming. If you still get humming with basic balanced wiring, there are much more to do to avoid it than with unbalanced connections.

Most professional audio devices are connected via balanced cables to minimize pickup of stray electrical noise. Consumer audio devices use unbalanced cables and are very prone to picking up noise, especially at low signal levels from devices such as microphones. Balanced circuits have an inherent ability to only pass audio signals and reject unwanted noise.

Balanced refers to the fact that there are two symmetrical signal lines and one ground, while unbalanced uses just one signal line in reference to ground. Normally, XLR connectors are used in most balanced devices while unbalanced consumer gear normally use mini-plug or RCA connectors.

Do not ground the XLR connector shells

The recommended practice in professional audio community is not to ground the shells of XLR connectors. The reason is XLR shell can come easily in contact with metal railings or something else which is grounded to somewhere else than your audio system. If your shells are not grounded nothing harmful will happen. But if you have for some reason grounded the XLR connector shell to audio ground you will get humming to your system because all kind of ground paths/loops and sorting you those can drive you crazy. It is best to leave the shells not connected so you don't add a new, intermittent problems, to your audio systems.

Transformer isolate all unbalanced connections

If you have a mixed balanced and unbalanced system, do yourself a favor and use isolation transformers in every connection between balanced and unbalanced system. When unbalanced lines cannot be transformer isolated, use special cable assemblies to solve the humming problems.

Use unbalanced cables for short distances

Any unbalanced cable must be kept under few meters in length. Cable lengths longer than this will amplify all the nasty side effects of unbalanced circuitry's ground loops.

Keep your audio cables away from power wires and transformers

Power wires generate magnetic field around them and this can cause humming to the audio cables. Especially avoid placing your audio cables near you main power feeding cables and cables which are connected to lighting system (the dimmers cause very fast current changes to cables which induce easily humming to audio cables).

Keep the audio cables at least half meter away from power cables. If the audio cables must cross power cable then they must cross them at exactly 90 degree angle to keep the hum coupling minimum.

Isolate ground in all wires which go to equipment connected to separate power feed

If you must connect equipments which are powered from other power source than your mixing desk then you must make sure that they don't cause ground loop problem. Safest choice is to use audio isolation transformer in every connection you need to equipments connected outside your dedicated audio power feed. For balanced connections also ground lift in audio wire is an acceptable way to isolate audio grounding between different system

If your power amplifiers are connected to different power feed than your mixing desk then use balanced connection between your mixing desk and the power amplifier and use ground lift to isolate audio ground in the cable (the ground lift should be done in the amplifier end). If you can't use balanced connection and ground lift then use isolation transformer in that audio line.

If your system has also video and/or computer equipments then give them a separate power feed. Use audio isolation transformers in all audio connections between your computer/video system and your mixing desk (computers and video equipments typically have unbalanced audio connections so isolation transformer is the only proper way to get rid of humming problem).

Keep some spare audio isolation transformers always available

Audio isolation transformers are very powerful tools for solving unexpected humming problems when you connect some extra equipments to your system. When you have some extra isolation transformers always available the problems can be solved easily and effectively whenever they pop up.

Keep transformers and power distribution panels away from your audio equipments

Audio equipments and wiring can very easily pick up humming from magnetic fields. So avoid putting any sources of such magnetic interference near your system. This applies to power transformers, video monitors, computer monitors, electric motors, fluorescent lights and any mains wiring which carry large currents.

Do not keep your cables coiled

Coiled cables form a coil which will easily induce magnetic field around them and pick up magnetic fields. If your power cables are tightly coiled they can cause large magnetic fields and heat too much up if loaded very much. Coiled audio cables can easily pick up interferences. If you have spare cables you need to put somewhere do not coil them just to a single coil, but instead put them in an 8 shape to ground (this shape greatly reduces the magnetic interference problems).

Star Grounding: One Path to Ground

Star grounding is the name Audio and Electrical engineers use to describe a wiring system where all the electronic SIGNAL grounds (cable braiding, jack sleeves or pin 1 on an XLR) either

- Flow through in a serial manner without coming into contact with the electrical or chassis ground on the way, or
- Join the mains power supply ground (the really really big thick green wire) at the one place and one place only.

This system removes the possibility of a potential difference between mains grounds or the connection of mains grounds being duplicated in an Audio system.

With star grounding systems the centre that is usually chosen is either the Main Mixing Console or the multicore snake or patch bay that is usually plugged or hardwired into it. The reason for this choice is that most Audio Systems only have one main mixing console and the vast majority of devices are connected to it.

Conformity with this grounding system will usually ensure that your system no matter how large will remain hum free.

Avoid connections to other grounds than your system ground

There are other things than the power connections which can me an unwanted grounding connection to your audio system. Audio connectors which have metal shell which is in contact with the cable shield can cause unwanted grounding if they touch any grounded metal in the building or some other grounded equipment. Same applies also to microphones and snake cable connection boxes. So if there is change that your exposed audio wiring ground can touch any building ground then put some insulation between your wiring and that ground. Avoid putting equipment racks over any metallic parts in the floor because it is possible that they are grounded for some reason. If you have to place equipments on such place then put some kind of carpet between the metal parts in the floor and your equipment rack to provide necessary isolation.

Use correct gain structure in your system

By using the correct signal levels throughout the system will minimize the humming, noise and distortion. Gain controls in PA power amplifier be typically set between half-way and fully up. Amplifier gain controls set at a lower position require input signals to be set to a higher level to obtain suitable power levels. Particularly with unbalanced input lines, the hotter your signal is at the input of an amplifier, the more noise propagation you will have into your amplifiers. If you have set the amplifier gain set too low your system may become such that you will reach the maximum gain travel of a fader, at your source device, before obtaining expected power within your amplifiers.

[Tomi Engdahl](mailto:Tomi.Engdahl@iki.fi) <Tomi.Engdahl@iki.fi>

How does balanced power help to solve ground loop humming

Using balanced power solves ground loop problems because it takes it's ground from one source, hence no potential difference. You can do this yourself simply by taking all power from one spot. If your equipments "leak" to the ground, then balanced power might be helpful.

How does balanced power work ?

Balanced power systems have been most commonly used with the 120V mains power used in USA. In normal wiring there is one neutral wire which is always at (almost) ground potential and other wire which carries the 12V AC voltage. There is also a separate safety ground wire.

In balanced power there is two out of phase 60V lines rather than normal 120V and neutral. The voltage difference between those out of phase 60V lines is 120V, so the equipments will get full 120V between their power input pins. The balanced power is generated from normal AC voltage by using an isolation transformer with centre-tapped 120V output and the centre-tap of the output is grounded.

That expensive power balancing equipment is just a 1:1 mains power isolation transformer with a center tap to ground, so that you have two legs of AC which are 180' out of phase with respect to one another (with respect to ground), so that your ground currents cancel out. The important fact not noted is that the center tap is also situated as a the center of the output voltage swing. That's the key in a balanced power system. Balanced power is not high tech stuff.

Power transformers don't need to be wideband, they don't need to have extremely low distortion, and they don't need to work on a wide variety of different voltages with extreme linearity. On the other hand, they do need to be able to work into a wide variety of loads. The transformers used in balanced power units are specially wound toroid transformers. The windings have to match perfectly or the "balanced" aspect of the power doesn't work!

How is the balanced power claimed to help ?

The manufacturers of balanced power systems claims that balanced power solves all ground loop problems in audio and video systems. Typical claims are also that you get much better noise margin.

If you have chassis leakage problems, it can be a miracle. If you don't, it doesn't do any better than any other isolation transformer.

I haven't had the need to use balanced power, but in theory it solves similar problems in a similar manner that a balanced audio signal does; namely noise cancellation. Not to blindly be relied on to fix everything or to be a substitute for careful troubleshooting.

The typical claim made by the the salesman of balanced power is: "When the power is balanced the mains cable has less electric field around them so they should induce less noise to nearby audio cables". Those claims are partially true, partially quite nonsense. If you placed an unscreened cable next to a balanced power cable, I would expect that less noise/hum would be picked up as the hum is capacitively coupled. If you placed a screened cable next to a balanced power cable, quite little difference would result if any. The capacitively coupled signal is now intercepted nearly completely by the screen. Practically only the magnetically coupled component will reach the screened signal wire(s). Magnetic field around the cable will be practically the same whether the mains cable is balanced or not as there is still the same mains current flowing up one wire & back down the other.

Balanced power can solve the ground leakage problems caused mostly by computers and badly designed audio equipments (mostly guitar amplifiers). When the leakage current is reduced to none using balanced power there is less noise in the ground wire. If you have a chassis leakage problem, balanced power will radically reduce your noise floor. If you don't, it won't help in your system.

If your noise is all hissy white noise from noisy electronics, balanced power won't do a thing. If your noise is mostly hum from power supply leakage on bad equipment (especially old guitar amps), it can do an amazing job. If it's hum from ground loops, it won't do anything (or anything more than plugging all your equipments to one extension cord). Balanced power is a particular tool to solve a particular problem.

Because balanced power uses isolation transformer this can help to stop some interferences from mains power to enter you audio equipment power system. But simple transformer does not usually do much help on this either.

Tips on buying balanced power systems

Sometimes balanced power helps, sometimes it doesn't, and it's nearly impossible to predict. The only advice I can offer is to buy from a dealer who will let you return it. But if you're having a hum problem, try to fix it by studying out your system grounds first. Equipment that is designed, built, and connected correctly shouldn't need a balanced power source to make basic problems go away. You probably can't do anything about the equipment design or construction (some people modify internal wiring to correct a manufacturing deficiency) but you can, by isolation procedures, examine your grounding and shielding to make sure you haven't created a problem.

Who makes balanced power systems

- [Equitech](#) is the pioneer of the balanced power systems
- [Electronic Specialits](#) makes [isolation transformers and power conditioners](#) for many different applications
- Furman makes cheaper balanced power systems
- [PowerPRO 20](#) is a balanced power product by [Cinepro](#)

Where I can find more information on balanced power systems ?

The following links to balanced power articles should give you a good overview of the balanced power systems. Remember that most of those articles are written by the manufacturers of balanced power systems.

- [Audio noise and AC systems revisited](#)
- [Lifting the Grounding Enigma](#)
- [Power management in studio](#)

There are other alternatives than balanced power

If you are looking to quiet down a studio you have also other alternatives than just go straight to balanced power system. Usually the ground loop induced humming problems can be solved with carefully designed audio and mains wiring. Taking the power for all equipments from single source usually keeps the humming problems away if the equipments are properly designed connected together in the right way.

Try a good common isolation transformer if you are trying to solve power line borne problems. And good quality 1:1 audio isolation transformer in problematic audio lines will always help you to get rid of humming and noise.

Some on-line UPS equipments provide galvanic isolation and good mains power noise reductions. UPS also provides you some safety against high voltage spikes and power interruptions. Be prepared to buy a good UPS with sinewave output because if the UPS output is not good sinewave you can get noise problems because of bad power that the UPS gives out. Stay away from the cheapest computer UPSes. The problem with these is that they have a lot of line harmonics on them, and they can make noise problems worse for that reason.

[Tomi Engdahl](mailto:Tomi.Engdahl@iki.fi) <Tomi.Engdahl@iki.fi>

Ground loops and audio racks

The equipments connected to metal audio racks will get connected to each other through the metal rack. This can lead to ground loop problems if the wiring is not done carefully. If you face this type of problems do not use insulating tape or other non-conducting materials to "cure" the problem. That could end up being very dangerous. Instead think of a redesign.

How to construct rack system

Assuming that this rack is the hub of your plant then proceed as follows. It's called hub and spoke grounding.

Begin with an empty rack, standing in the middle of the floor. First, bring AC to the rack, allowing for expansion. Buy one or two five-foot pieces of wire mold with receptacles spaced every four inches. Bond the green wire from the receptacles to the rack so that the rack is at the same electrical potential as the earth ground for the AC. You can add more racks and wire mold strips as needed until you have adequate rack space. Bolt all racks together until there is NO question that they are electrically just one piece of metal.

Mount the power supply for the console in this rack. Mount all outboard equipment in the rack. View the rack as a hub for ALL business at your plant. Start substituting the word "hub" for rack.

Spoke #1: Run a single piece of grounding from the hub to the console. Make it big. Wire the power supply to the console. Now cable other console items back to the hub. NO OTHER COMPLETE ground connection allowed between hub and any other terminal point: Open the shield, for the sake of uniformity, at the terminal end for every piece of shielded cable, leaving each shielded cable grounded at the hub end. Your single piece of grounding is what keeps it all safe -- and silent.

Spoke #2: From the hub, run AC to, perhaps, a free-standing tape machine. Ground it back to the hub. As above, run signal cables to the hub, grounding the shields at the hub only.

Spoke #3: From the hub, run AC to, perhaps, a rack in another studio in your plant. This new rack becomes a hub for the world it lives in and it has ground wires emanating from it to new terminal points.

Spokes #4 through 400: As above.

NEVER NEVER NEVER: Here it is, here is what keeps it all honest and hum-free: NEVER take a shortcut and run a cable directly from one terminal point to another. ALWAYS run such cabling back up the hubs spokes to the main hub and then down the appropriate spoke to the desired terminal point, tapping into hub grounds all along the way.

How to test that you don't have ground loops

Buy a digital clamp-on current meter. There should be NO current on any ground wire. None. If you can measure current flow on a ground wire then fix it: you either have a circular path or else a faulty piece of equipment.

If you can't get clamp-on meter you can try to measure the current flowing on audio cables by removing the cable from one end and connecting an ordinary multimeter between the ground pin in the audio wire and the audio connector ground pin in you equipment it was connected to.

How to make connections to other equipments not part of the system

When connecting a system which has well done non-humming grounding and a system running from another power source, the signal grounds of the systems need to be isolated.

With balanced audio signals, lift the shields at the inputs. With unbalanced audio or video signals, use an isolation transformer or wire the signals to balanced input where the ground connection is left open.

Ather rack wiring ideas where ground loops are not a problem

If all your equipments are just in one rack then you can also use another wiring method. Instead of avoiding gound loop you can try to make the whole system to have a very stable common grounding. This stable common grounding can be achieved by making sure that all equipments have very good connection to metal rack. The mains power to all equipments mut be take from one power distribution unit installed to the rack case. If all wirign is done using short wires the system does not have grounding problems because there can't be any significant ground potential differences because all equipments are well tied to one very low resistance ground (the audio rack+the metal equipment cased tied together).

[Tomi Engdahl](mailto:Tomi.Engdahl@iki.fi) <Tomi.Engdahl@iki.fi>

Published by ELH Communications Ltd. all rights reserved.

Methods for breaking ground loop

Fort check that you have made the cabling between equipments properly. Proper audio cable connection methods are essential in getting humm free system. [Rane](#) technical note [Sound System Interconnection](#) is a very good source for information how the audio wiring between equipments should be connected. This is a well worth to read article.

Breaking of ground loop can be done in many ways, some which are better and some are less good.

Dangerous method: break the mains ground connections

Logically you could think, you could eliminate ground loops by disconnecting the power-cord ground pins on all your gear. Some people might try to break the ground connection by cutting the grounding pin in the connector, using [cheater plug](#), cutting the ground wire in equipment, taping over the grounding connector etc.

Do not do this. Removing the ground connection isn't right. It is against electrical safety regulations and potentially very dangerous. Removing ground connection can defeat the actions of your noise filter or spike protectors inside the equipments. If the ground connection is cut then a fault in the insulation inside equipment will cause dangerous voltages to the equipment case instead of burning a fuse. Removing the ground connection from the equipments which have it is dangerous, against electronic safety regulations and you [risk damaging your equipment](#). Running without a power ground will not automatically electrocute you but will make this much more probable if something goes wrong in your system.

NEVER use a three wire to two wire adapter on ANY piece of audio gear where a human can POSSIBLY come into contact with it. You're asking for a nice 120v "signal" thru someone's body. Yes it MIGHT eliminate the hum, but there's a MUCH safer way to do the same thing.

Is a GFCI a substitution for ground conductor ?

[Ground fault interrupters](#) can be used as replacement for ground connections in three prong receptables according NEC. The NEC requires that three prong receptacles without ground that are protected by GFCI must be labelled as such.

The NEC, section 210-7(d), and CEC, section 26-700(9), are quite explicit that GFCIs are a legal substitute for a grounded outlet in an existing installation where there is no ground available in the outlet box. But your local codes may vary.

Because the NEC talks only about existing installations without ground it seems that you can't use GFCI as ground fault problem solver, because your system already have grounding (and GFCI is a substitution for grounding in installation where there is no ground conductor).

Transformer isolation of whole studio system

You can isolate your system completely from the power company with a special transformer. But if you're going to go to the trouble of doing this, you might as well consider rewiring your studio with good power system which has proper star grounding. The use only professional equipments with balanced audio input and outputs and do the wiring correctly. If you still face problems you can consider using [balanced power system](#) to power your equipments.

Solving the ground loop hum problem using the right ground loop isolator is the safe, effective way to eliminate unwanted hums at an affordable price. Typically ground loop problems can be solved with [audio isolation transformers](#) connected to the audio line. There are also commercial audio distribution amplifiers which provide this isolation.

Regardless of what type of ground loop isolation method is used, remember, **never remove the ground prong on the power cable**. This may work as a temporary solution, but personal safety should not be compromised.

If you can't find the ground loop and don't want to use isolation transformer, try tempting the circuit with an even better ground. Heavy-gauge wire has very little electrical resistance, so less current is likely to flow through the shield. Get some heavy gauge wire and run lengths of it from your computer's chassis to each other chassis. On audio equipment, there's usually a screw marked for this purpose. You should hear the hum go down as soon as you make the connection. If heavy-duty ground connections don't stop the hum, you'll have to use suitable isolator in that audio line.

Direct (DI) boxes as ground loop problem solvers

Direct boxes are devices that convert unbalanced instrument-level (or line-level) outputs into balanced, microphone-level inputs. They are used heavily in large, arena-size sound reinforcement systems where the keyboards, etc., are located far away from the mixer. Impedance differences between the keyboard and mixer prohibit one from running cables directly out of the bass amp of keyboard and to the mixer.

To use the Direct Box, one takes the guitar amp's output (it usually has one on the back), and, using a 1/4" patch cable, plug the other end into the direct box input. Make sure that the switch (if it has one) labeled "Speaker/Instrument" is on "Instrument." Plug a normal XLR cable into the output end and the other into your cabling which goes to the mixer.

If the system is grounded at both ends and ground potentials start flowing, you'll get a ground loop. Ground loops can be identified by a low hum (60Hz in the US and 50 Hz in Europe) through the sound system. First place to check: direct box. Direct box usually has a switch labeled "Ground Lift" for solving this type of problem. The ground lift switch will lift the ground (safely) and the hum should stop. If the switch isn't there, use a special ground lift cable on the XLR cable. Do not, by any means, disconnect the grounding pin of the AC cord.

How to use noise gate to reduce hum

Noise gate does not let any sound through the gate unless the sound has a signal level which is higher than the set threshold value. If the problematic hum source is some instrument and the hum is very faint a noise gate can make less annoying. When you set the noise gate threshold so that the gate does not pass any signal when there is no signal from the instrument then the hum is not added to the main mix. When the instrument is played a very weak humming is quite hard to notice.

Commercial products for audio line ground loop elimination

- ES034 Ground loop isolator - isolation transformer for car audio from [Scosche Industries](#)
- FGA-40 Ground Isolator is 1:1 audio isolation transformer with 10 kohm impedance from Monacor (Best.-Nr. 06.4370)
- Ground LP Isolator (270-0054) from [Radio Shack](#), designed for car audio

Equipment to remove hummign already in signal

- [N'Hummer 1a AC Line Noise Eliminator](#) from [Stro Lion Technologies](#)
- SN-700 Noise/Hum Eliminator - a single-ended, realtime noise eliminator which tries to eliminate humming noise form audio lines, made by Roland.

Reducing Microphone Hum

Microphones and microphone cables are especially sensitive to hum pickup because of the great amplification needed for microphone level signals (few millivolts). The hummign can be caused to microphone signals because of ground loops and because of induced noise. Here are some tips to minimize microphone hum pickup:

- Use low impedance microphones (150-6000 ohms). All modern recording equipments and mixers are designed to work with low impedance microphones.
- Use microphones with balanced outputs (three pin XLR connectors). Thus kind of microphones pick up less hum than unbalanced microphones.
- Routinely check microphone cables to make sure that the shield is connected at both ends.
- Check that the screw near the XLR connector on the microphone is securely screwed in place inside microphone handle.
- Do not connect the ground on XLR connectors to the shell of the connector, because ground loop hum may occur if a grounded shell touches a metallic surface.
- Do not ground microphone junction boxes or snake boxes except through the cable shield.

[Tomi Engdahl](#) <Tomi.Engdahl@iki.fi>

Ground lift

The current which flows in the ground loop flows through audio cable shield. In balanced connections the current flowing in the shield should not effect the signal in the cable or this signal connections in equipments. If the equipments are well designed (cable shield grounding is done in the right way) then small amounts of currents do not cause any problems. In practice equipments are not that well designed and even very small current can induce humming to the system.

If you cut the audio cable shield the current will stops flowing but exposes this audio line to other kind of problems: if one of the equipments is not connected to electrical grounding, then the equipment don't have any common ground which then not to work as expected.

To avoid this kind of problems and still limiting the current passing in cable shield wire to value which does not cause problems an scheme called **ground lift** is introduced. Ground lift places a resistor (usually around 100 ohm) between the equipment ground and cable shield. This resistor limits the current passing in the ground loop situation, but still provides quite good ground connection. This system is unfortunately quite sensitive to radio interference, so the 100 ohm resistor is usually shunted with small capacitor (usually 4pF to 10 nF) which makes the impedance to be low at radio frequncies but does not let too much 50 Hz current flowing.

Before trying to use **ground lift** circuit is is best to check that everything is otherwise wired correctly. It is stupid to use ground lift trick to fix other problems in the system because ground lift does has it's own problems. A good document how to do the audio wiring correctly is [Rane](#) Note 110: [Sound System Interconnection](#).

Ground lift in balanced connections

Full ground lift circuits for balanced XLR connector

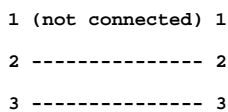

This is the most basic ground lift circuit which works nicely when all equipments are grounded and have balanced inputs/outputs. Because the cable shield is cut the cable this arrangement makes the cable more prone to pick up radio frequency interference. This kind of ground lift circuits are built-in to some equipments (can be activated using switch) and they are available as ready made products (like [GLX GROUND LIFTER](#) and similar).

The shield of the cable is conneted to pin 1 only in one end of the cable. It's more common to tie the shield at the sending end and lift it at the receiving end. Either way will work, but tying the shield at the sending end has some advantages for reducing crosstalk.

Partial ground lift with RFI filtering for balanced XLR connectors

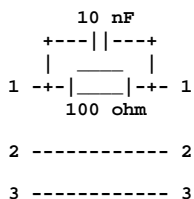

This ground lift connection does not fully cut the gound carrying cable shield, but increases the resistance so much that the currents which would flow in the shield in typical ground loop situation are limited to so low values that they have no effect in system performance. Because the ground is not completely cut then the circuit also works also when ungrounded consumer equipments

with RCA->XLR adapters are connected to the system. The capacitor makes sure that the cable shield appears to be continuous to the radio frequency signals (radio frequency interference protection provided by shield is not lost). This circuit is quite universal and I have used this circuit for successfully solving some balanced circuit ground loop problems.

Telescoping shield cables

In the audio world, there is a solution to ground loops called "telescopic" ground and "Faraday shields." A telescopic ground works only with a cable which is a balanced line, that is, one which has two wires to carry the signal and a separate shield. In a telescopic ground, the shield is connected only at one end. This prevents the completion of the 'ground loop.'

Best telescoping shield cables (true telescoping shields) are constructed so that they have two shields which are insulated from each other. The idea is that you connect the inner shield to ground only at receiving end and the outer shield to ground only at the transmitting end.



In this way the ground loop is effectively broken but the RF shielding properties of the cable are still very good. Double shields and the capacitive coupling between (they are near each other in cable) form a good shield for radio frequencies. It has been claimed that telescoping a shield in cables with hybrid unbalanced/balanced audio systems is often very successful at removing noise. The telescoping shield protects the inner conductors and drains away that unwanted noise to one location. Shield effectiveness gets less and less as you travel further from the grounded end.

Telescopic grounds cannot be used in unbalanced circuits, such as unbalanced audio interconnections and video coax, as the two conductors necessary to send the signal include the shield. That is, the shield is both the noise-reduction portion of the cable and a signal path as well. Ungrounded that and, if the signal gets through at all, you will have the world's noisiest circuit as the other path (what was the shield) will be established through some other ground path through other equipment!

Some notes on using ground lifts

Disconnecting the screen in balanced audio cable will break the ground loop and possibly eliminate hum. But a word of warning before disconnecting the screen. If you are running equipment from two or more separate power receptacles, especially if they are widely separated and the building wiring is old or not up to spec, there may be residual 50 or 60 cycle voltages present between the two alleged ground connections. These will be small, of the order of millivolts, unless something is seriously wrong with the building system, but they may be large in terms of audio signals, and can do a lot of damage if fed into a high gain audio input. So it is important to try the effect of ground lift at low gain first.

Ground lift for unbalanced connections

Situations where two grounded equipments with unbalanced connections are connections have ground loop related humming problems and no other solution helps then you can try to use ground lift. Ground lifting in unbalanced connections works only effectively when both of the equipments are properly grounded to same point. In some cases the humming problem may become worse if ground lift is used. So ground lift in unbalanced connections is not a foolproof method and it should be only used as temporary solution.

Here is a typical ground lift circuit for unbalanced connections:

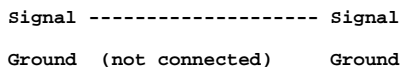

Try this circuit only if you know that both equipments are properly grounded. If the equipments are properly grounded this circuit will cause enormous amounts of humming and potentially damage the input amplifier of the receiving equipment because of the flowing stray currents on the ungrounded equipment. The best solution for solving unbalanced connection ground loops is using audio line isolation transformer.

Note on using the circuit: Because this circuit cuts the shield of the audio cable this greatly reduces the RF shielding which the continuous cable shielding normally provides. If you are using the circuit above be sure that there are no severe RF interference sources like mobile phones or communication radios near your audio system. The RF shielding of the circuit can be made better by using the circuit above which provides cable shield continuity to RF signals but works as ground lift for audio frequencies.

If you happen to use RCA connectors in audio connections, you can try if this ground lift helps if you partially remove the RCA connectors, so that

the center pin touches the jack, but the outer ground does not connect the jack side. If this solved the problem then you can do the ground lift circuit. In RCA connectors you can do the ground lift by inserting a rolled-up paper strip or plastic cut from plastic back between the RCA jack's ground shield and the receptacle. Another solution is cut the cable ground connection inside the jack.

If you are in buiness of modifying a cable to include groundlift option I would recommend adding a small capcitor to the place where you cut the cable to reduce the possibility of the ground lifted cable to pick up RF interference:

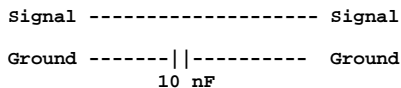

Using ground lift circuits

Ground lift circuit would reduce possibilities of audible ground loops. A truly covers-all bases piece of equipment would have a switch to activate or deactivate the ground lift. To test if your equipment has ground lift, insert a balanced TRS or XLR cable into the equipment, and measure the resistance between the shield contact of the exposed connector and the casing of the equipment or the earth pin of the mains cable of the equipment, using a multimeter. If there's a 100ohm to 500ohm resistance, your equipment is ground lifted.

Ground lift is quite effective in balanced audio connections, but is much less useful in unbalanced connections, which is the connection type used in almost all consumer audio equipments. You might try this ground lift scheme with this connection type, but the results would be much worse. Even when you can limit the shield connector current to values which do not cause problems, there is still the ground potential difference between equipments which gets amplified (and you get still some 50 Hz noise). Even ground potential differerences much lower than 1 mV can cause serious noise problems with unbalanced circuits. If you have unblanced connections, I would advice you to use audio isolation transformer instead of ground lift when you are solving problems with nonbalanced audio connections.

[Audio Wiring and Grounding](#) article from [Equitech](#) web site provides more information how ground lift is wired and how it affects the audio system performance. [Wires and connectors article](#) at [Multimedia Bluffer Guides](#).

You can easily test the effectiveness of ground lift in your system. urn the volume down, disconnect the shield at one end, and slowly bring the volume back up. It's easy if you've got phono connectors--just pull the plug partway out, so the pin makes a connection but the outer shell doesn't. Be warned: If other grounds aren't good enough or mose of the equipment are not grounded at all this will cause an even worse hum. If the PC is not properly grounded this kind of experimenting can even cause damages to audio equipments.

[Tomi Engdahl](#) <Tomi.Engdahl@iki.fi>

Audio isolators

Isolation transformer for audio lines

Audio isolation solves groundloop problem

If you want to do the ground loop elimination in audio path, you have to cut the galvanic connection but pass the whole audio range. The simplest and most common way to do the isolation is use audio transformer which is ment for audio use.

Usually when you install an audio galvanic isolatio (any type) to almost any place in the audio cable connection is solves the ground loop caused humming problem nicely.

Possible isolation components

The most suitable component for audio line galvanic isolation is audio transformer. It is very compact, completely passive and widely available. For audio signal isolation transformers are the way to go and they have been used for this application in audio studios successfully for test of years. In audio studios commonly used technique very traditional is to balance the lines between the systems using audio transformers which do the balancing and galvanic isolation.

While optoisolators can be used to isolate grounds they have insufficient linearity and dynamic range for analog audio. Optoisolators have also the problem that circuit using them will always need some external poer source to operate. I do not recommend using optisolators for any high quality audio isolation application.

Transformer use

Cheapest transformers for audio use have some problems on the sound quality, typically distorted bass response and attenuating in high-frequency response. Basically a poor transformer slows down upper frequencies and allow the low frequencies to pass first, creating what we perceive as a "fat/warm" tone. Inadequate frequency response on the low end (rolloff at like 20Hz), causes low frequencies to be "slowed", allowing the upper frequencies to be heard first, this is perceived as "barky/ brittle".

High-quality audio transformers cover whole audio band with good response, but those are quite expensive. Depending the application you might have to do some weighting against the price of the transformer and the sound quality.

Whenever possible, an input transformer should be used at the destination end of an interconnect cable. Input transformers offer much better Common Mode and Radio Frequency Rejection than is possible with output transformers.

Audio isolation transformer product information

There are ready made circuits available from shops selling car audio stuff (ground loops are usually problem also in car environment). If you live in USA, take a look in Radio Shack's catalog on car electronics or check the [Radio Shack Product Support](#) pages which have specifications of Ground LP Isolator (270-0054) which cost about \$15US. Might not be the highest quality solution though. If you are looking for very good sound quality, you might want to invest to some better quality (and much mor eexpensive) audio transformers.

For more professional product check JK Audio Pureformer Stereo Isolation Transformer. Those products seem to be quite suitable for solving ground loop problems in consumer audio systems, but I have not tested them myself.

Europeans should take a look at their nearest dealer which carries Monacor products, because Monacor's new catalogue lists FGA-40 (Best.-Nr. 06.4370) Ground Isolators which are 1:1 audio isolation with 10 kohm impedance (cost around \$20). I have used this isolator successfully in some audio installations and I am quite satisfied with that as a problem solver. I have found that the transformers in this product will attenuate the low frequency signals if the transformer is driven by high impedance output, because the impedance gets quite low on lowest frequencies.

For professional audio use buy high quality commercial audio isolation/balancing transformers (those are very handy to keep around to solve unexpected ground loop problems).

Balancing the line and removing of humming in PA systems instrument connection can be achieved too by using passive DI boxes, available at your local music stores. Many DI boxes are active and can be almost useless in getting rid of earth loops and stopping buzzes & hums etc. A GOOD passive DI which provides isolation is proven only way to go. (Active ones work also if they are properly designed and provide necessary ground isolation).

Commercial products

- [Biltema 31-441](#), check [measured results of performance](#) (text in Finnish)
- [Cordial CLT 1](#) - 600/600 Ohm. line-transformer for the galvanic separation of the sound signal
- [Furman Iso-Patch IP-2](#) transformer isolator
- Monacor FGA-40 (Best.-Nr. 06.4370) Ground Isolators - 1:1 audio isolation with 10 kohm impedance
- [Jensen Transformers](#) - company which makes audio isolation transformer and DI boxes
- [Leon Audio Active Direct Box](#) - includes earth isolation
- [Leon Audio Passive Direct Box](#) - audio isolation transformer
- [Lundahl Transformers XLR inline transformer units for breaking up ground loop in audio systems](#)
- [Pyramid RCA Isolation Transformer](#) - stereo isolator with RCA plugs, designed for car audio
- Radio Shack Ground LP Isolator (270-0054) - cost about \$15US, RCA plugs, for car audio

[Tomi Engdahl](#) <Tomi.Engdahl@iki.fi>

How to build your own audio isolator

Building yourself an audio isolation transformers

If you want to build one yourself, you have to get two audio transformers which have 1:1 transformation ratio and greater than 1 kohm impedance. There are high quality audio transformers in the market that meet those specs, but those can be quite expensive. Another option is to use 600:600 ohm isolation transformers widely available for telecommunications and other uses. Those are not that high quality as good audio transformers, but can be well adequate for many not so demanding multimedia applications like computer audio if suitable transformer is selected.

Isolation for unbalanced lines

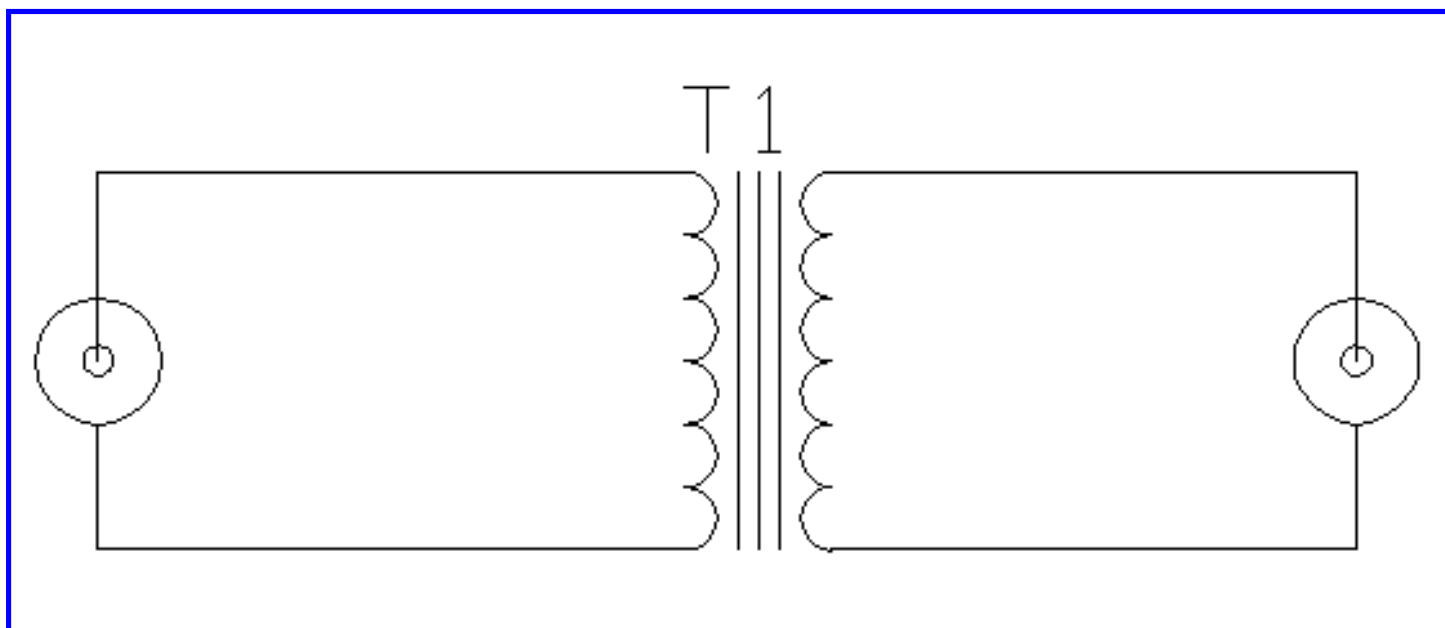

Notice one thing in the transformer wiring: Many transformers have the coil starting marked with dot. If you put the audio signal to the transformer in such way that the center wire in RCA connector is always connected to the coil end marked as coil start you will get a nice isolator. If you for some reason connect the wires in one side of the transformer in the wrong way, your transformer will cause a 180 degree phase shift to your audio signal. If some of the signals in your audio system will get this kind of phase shift and some other will not, you will face all kinds of sound quality problems. If you have this kind of system, it is best to test that the audio isolation transformer will not cause unintended phase shift to the signal.

The transformer used for this should have a flat frequency response over whole audio frequency range, should have high enough impedance at lowest frequencies and should not cause noticeable distortion. If the impedance drops on low frequencies, this can cause attenuation of the lowest frequencies if the transformer is connected to the equipment which have a very high output impedance.

This kind of isolation transformer circuit should be best connected on the receiving end (equipment input) end of the cable to get best performance. If the cable is not very long (not many meters), in practice it does not matter to which end of the cable this transformer isolation circuit is connected.

Isolation for balanced lines

For balanced lines equipped with XLR connectors the audio signals are transported between signal pins 2 and 3. So the isolation transformer should be wired so that the primary is wired between input XLR pins 2 and 3 and the secondary is wired between output XLR pins 2 and 3. The grounding pin 1 of the output XLR connector can be wired to metal case of the isolator, but do not connect the input XLR connector pin 1 to anything.

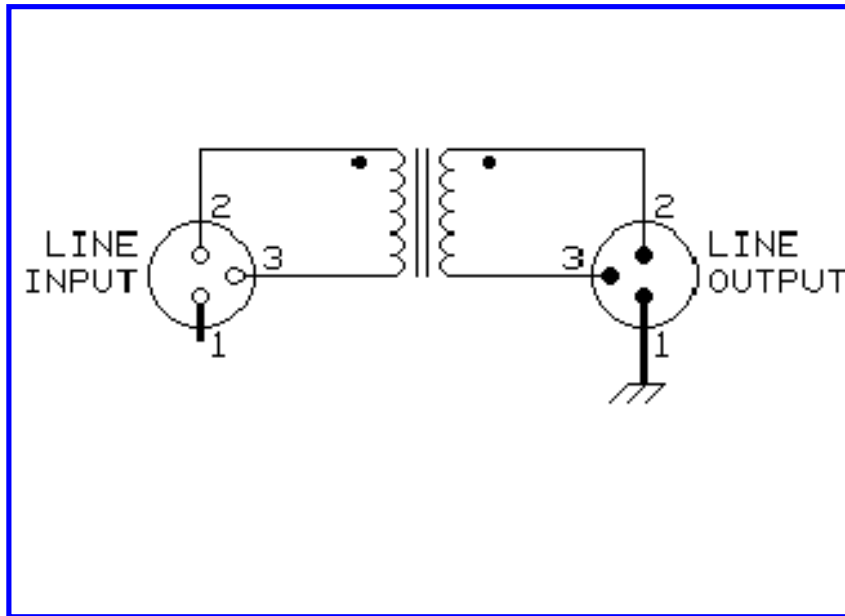

The transformer to be used in the circuit above should be 600:600 ohm audio transformer which can handle the signal levels you are about to transfer through the isolator without causing too much distortion or other problems (not very low signal level microphone transformer for line signals etc.). The transformer which is used should have very flat frequency response over the whole audio frequency range (20Hz..20kHz) and even more. This kind of isolation transformer circuit should be best connected on the receiving end (equipment input) end of the cable to get best performance. If the cable is not very long (not many meters), in practice it does not matter to which end of the cable this transformer isolation circuit is connected.

[Jensen Transformers](#) has a good application note [JT-11SSP-6M 600 Ohm Line Isolation Application](#) which describes how to build a very nice isolation transformer for 600 ohm balanced audio lines. Other simpler design is described at [JT-11-DM Basic Hum Stopper Transformer isolation box](#). Both of the designs use more components than my simple design but are expected to perform better under strong RF fields.

Circuits I have built

Circuit using telephone line transformers

I built my first isolators using two high quality telephone line coupling transformers which have 600 ohm impedance. This is the most commonly transformer type used in high-speed modems. Best of those are quite wideband devices (far more bandwidth than usual 300-3400 Hz as used in telephone). Using two of those transformers and few RCA connectors made quite satisfactory (but not really hi-fi) audio isolator. The connection is easy: connect primary side of the transformer to one audio connector and secondary to other.

I used EOP Z1612 transformers in my test circuit and got quite acceptable frequency response of ± 1 dB from 40 Hz to 20 kHz as you can see in figure below. The bass frequency below 40 Hz is not good.

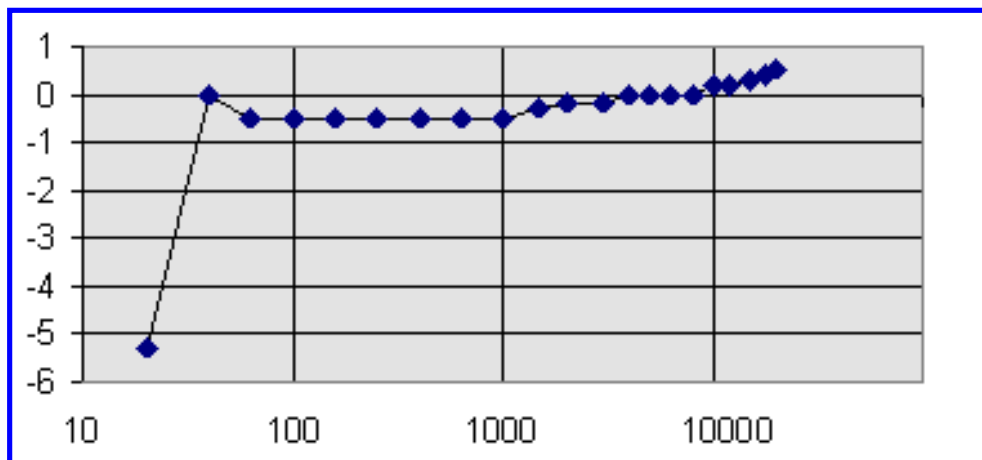

The frequency measurements were made with Nacamichi T-100 Audio Analyzer and the isolator circuit was connected between its 600 ohm output and

50 kohm input. I don't know if EOP Z1612 transformers are still available at [Farnell](#), but you can try. If you are looking for other high quality transformers which could be a used, I would try ETAL P2001. I haven't been able to test their performance in this application, but they have proven to good transformers in other laboratory test and applications. Avoid cheapest telephone and audio transformers, because their performance is very poor at frequencies over about 5 kHz (for example Radio Shack (273-1374)).

Transformer isolation using audio transformer

One way I got my hands on the component of old cenral radio systems amplifiers. Those amplifiers had a transformer isolated balanced audio input with impedance of around 1 kohm. I took the high quality input transformer from the preamplifier board and tried how well they would work in my applications. The text on the top of the transformer indicated that those transformers were 1000:1000 ohm audio transformers. The measurements showed that those transformers perform better than those telephone transformer.

I took a project box and pair of XLR connectors to make a nice set of audio isolation/balancing transformers for professional audio system. I keep those boxes with the audio wiring set and use them as problem solvers if there is some humming problem in the system which can't be easily solved in other ways.

Notes on selecting audio transformer

If you want the best sound quality (not much sound degraation) you must select a good audio transformer. Any transformer of the proper ratio will give you a high impedance input, but not any transformer will sound good. Cheap transformers add distortion, mostly at low frequencies, and it's not the "good" kind of distortion. They also tend to have poor high frequency response.

Makign good audio transformers is not easy. Lower impedance transformer are generally easilier that higher impedance. High Z primary is difficult to wind because the capacitance between windings starts to become a big issue with that many turns. And that kills your high end.

There was a day when audio transformers were commodity items and they were in everything, but now they aren't so common and as a result, the cheaper ones aren't in the catalogues any more, and the better ones ccost more than they used to because there aren't the economies of scale.

If you get a cheap transformer, you will eventually get depressed with the way it sounds, and you'll be spending the money on a Jensen, a Reichenbach, Sowter, or Lundahl (or any other reputable manufacturer) anyway. So you might as well just get it now and save the wasted time effort and money.

[Tomi Engdahl](#) <Tomi.Engdahl@iki.fi>

Digital audio and groundloops

Basics of digital audio interfaces

Digital audio connection (AES/EBU and S/PDIF) are not by themselves sensitive to groundloop problems. A small ground loop hummign does not change the digital data at all. If the ground loop problem is really serious, then some problems are possible. Basically in digitla interfaces the signal either get through correctly or not.

Although the digital audio connections themselves are not much disturbed by groundloops, they can be sometimes the connections which form the loop and cause a noise entering to the analogue connections of the equipments on the both ends of the digital connection.

AES/EBU and S/PDIF-connections were originally designed so that they should be free from groundloop. AES/EBU-interface uses the well known symmetrical connections with transformer isolation and an output impedance of 110 ohm. So an AES/EBU connection on the professional equipmet should not cause any groundloop problems when connected properly.

S/PDIF-connection (also known as IEC60958) was also originally designed to be transformer isolated at the transmitting end. So theoretically ground loops should be impossible, as each coaxial S/P-DIF output should be equipped with an insulating transformer, in order to avoid ground loop problems. But in reality the sitation is not so good, because in some cases because in some equipments the S/PDIF-output are not isolated from the rest of the circuitry.

Reasons for S/PDIF-problems

In reality many coaxial S/P-DIF inputs and outputs of soundcards and such devices lack such transformers. Maybe those products are so cost sensitive that the manufacturers have to cut corners in this way. And, even if the coaxial S/P-DIF output of an audio component is equipped with a transformer, hat doesn't mean that the output is isolated, because in some equipments the ground of the S/PDIF output connector (RCA-connector) is still permanetly connected to the same ground as all the audio connectors instead of correctly left floating.

Usually the absense of isolation in S/PDIF-connection is not a problem in normal use, but can be a problem among with those audio experts who want the best sound quality without humming. Usually the noise and hummign problems are the reasons to go to digital audio transmission, and it is quite sad that some manufacturers put out products which can't usually fulfill their promises in real life applications, because of the S/PDIF-interface ground loop problem.

Solving the problems with S/PDIF

If your sound card equipped with optical S/P-DIF (Toslink) inputs and outputs, try to use them instead of coaxial ones. The optical cable will mode the digital audio signals but at the same time provides a complete galvanic isolation between equipments. So optical interfaces are free from humming.

If you want to use the coaxial output and your equipment with S/PDIF output lacks the output isolation transformer on S/PDIF-connection you have to make your own extra isolation transformer.

Elector Electronics magazine issue 7-8/1999 recommend building the transformer for S/PDIF isolation in the following way:

The transformer must have good coupling factor, so the transformer core must be a toroidal core made of high permiability material. The prototype described in the magazine uses Philips Type TN13/7.5/5-3E25 core which has permiability rating (μ t) of 4500. The primary and secondary windongs consisted of 6 turns of 0.5 mm diameter enamelled copper wire laid on opposite sides of toroid. The transformer used in this prototype was described to have a bandwidth raged from 50 kHz to 17 MHz, which is more than adequate for an S/PDIF link.

The transformer should be fitted directly to the source and the receiving end must be properly terminated for reliable operation. The reason for this

is that the transformer input and output impedances are not exactly 75 ohm.

[Tomi Engdahl](mailto:Tomi.Engdahl@iki.fi) <Tomi.Engdahl@iki.fi>

Published by ELH Communications Ltd. all rights reserved.

Grounding and Rack Installations

General practices

In the data and broadcast world, virtually all equipment is mounted in upright metal cabinets or racks. By doing so, it is easy to establish safety ground and mechanically stable construction. When all equipments are mounted on rack cabinets which have grounded with a large wire running to a central ground point it is easy to establish safety ground.

Second, and most likely, conduit running in and out of the rack will be the mains power cord. Virtually all professional audio and video equipments have a grounded (three-pin in USA) power cord. That the grounding connection in power plug is connected inside that piece of equipment to the metal box or chassis of the equipment thus grounding the box and reducing the possibility of shock hazard to the user.

There are also other ground circuits going into and out of the equipments and equipment rack. If shielded signal cables are used for input or output (as almost always is), the shield of the cable is grounded to the metal box of that piece of equipment where the cable is connected.

Generally in the data world, shielded data cables are often attached to both the transmitting box and the receiving box. In video circuits, likewise, the ground is connected at both the source and the destination. In audio circuits, as well, shields are attached at both ends of each cable. (there are few special exceptions to those rules but they are quite rare).

Where the problems come

When the video and audio cables are wired between the equipments in the same rack cabinet, there is not problems to be expected because all the equipments are tightly grounded together.

But problems can be expected as audio, video or data cable could be attached between two pieces of equipment in separate rooms, separate floors or even separate buildings. If the ground connection is good at the both of the ends of the cable and there is any voltage difference between those two grounding points where the equipments on the ends of the cables are connected, significant voltage current travel down the shields of the cables. This current flowing on the cable shields can induce humming noise to the signals inside the cable and inside the equipments connected to the cable.

You can see up to many volts of voltage on between the cable ends and up to amperes of current flowing on the shield which should only have micro volts, or millivolts of noise.

Even in buildings with excellent ground systems, the distances run can be so great that the natural resistance of the copper wire and metallic conduit materials guarantees that there will be voltage differences from one part of the building to another. Running a shielded cable between the ends virtually guarantees a ground loop and, there, hum or interference of some kind.

The effect of this huge amount of noise varies. In video circuits, it show up as "hum bars", buzzing slow moving bars which wipe across the screen diagonally. In audio, it can be heard as hum, buzzes or other constant interference. In data circuits, it can cause bit-error-rates which can shut down a system where nothing else is actually wrong.

Quick fixes for problems

Quick fixes are available for all these problems which attempt to eliminate the problem without addressing the actual problem of poor grounding.

In the video world, one can purchase a "hum-bucker". This is a toroidal transformer wound to reject 50 Hz or 60 Hz (the frequency of the power line and most prominent frequency in the noise of a ground loop.). They are generally quite good in rejecting the mains induced frequency, but are generally a little bit bulky (somewhat large and heavy to be put in the middle of the cable connection), expensive (usually \$100-200 per line) and hard to find.

For audio wiring, the insertion of an isolation transformer provides galvanic isolation which prevents ground loops. Transformers are passive devices which use two coils of wire wound on one core made of magnetic material (like iron or ferrite). While the signal can cross between the two coils magnetically, there is no physical contact. Thus, the ground loop is broken. Adding isolation transformer to each audio line is usually expensive and can make the sound quality somewhat worse than straight wire.

In the data world, they avoid the problem altogether by using unshielded twisted pairs (UTP). This kind of wires are isolated from one or both of the ends of the connection. This has proved to be a wholly acceptable solution and works well in practice. Most of the modern office LAN cable wirings are nowadays done using unshielded twisted pair wiring (and rest of them most often using shielded twisted pair wiring).

However, for the audio and videoworld, unshielded cables are not an option for any serious high quality signal transmission. There are some adapters available to transfer audio and video using unshielded twisted pair wiring, but those adapters are generally only suitable for not demanding applications like security cameras (CCTV) and similar applications where the absolutely best signal quality need not be preserved. In any case going from normal video or audio connections to unshielded cable needs special converters which cost money and there is no guarantee that such converters will solve the initial grounding caused noise problems (they are just designed to be wiring media converters, not groundloop problem stoppers).

Analog audio and video designers do not have an option of using unshielded twisted pair wiring as general media for signal transferring and must use shielded wire for optimum performance. The only option then, is to eliminate the difference in potential between any points wired with cable.

Star grounding solution

There are a number of ground schemes intended to eliminate ground loops. The most common is called a star ground. In a star ground, a point is chosen as the lowest potential. There are conductors radiating in as many directions as necessary from that point (hence the "star" name). Those points should end up in every room that will have equipment with signal cables.

When all the ground conductors to star central point are of equal length all the ends of the star are, by definition, at the same ground potential and signal wiring between any equipment grounded to any of the points of the star will also be at zero potential. Therefore, no ground loops are created.

The idea that the ends of the star are at equal potential because they are equal length is critical to the success of this configuration. In order that the ends of the star are very low potential (low resistance), they must be large gauge wire.

Wiring between buildings

You can almost guarantee a serious ground loop if you are running between two buildings. This is because each building probably has its own source for power from the power company and each building has its own central safety ground point. Since this point is not the same point for both buildings, and since the ground in one building is often at somewhat different potential, there will automatically be a potential difference between any wiring run between the two buildings. Potential differences can be in some cases (power faults, lightning) can be dangerously high and the current flowing in wire shield can be dangerously high.

I do not recommend any direct galvanic connection using shielded cable between different buildings unless you absolutely know that it is safe to do so. Generally the connections between different buildings should be galvanically isolated (like for example telephone connections, the line itself is not grounded on the building where it enters) and they should be protected against fault conditions (overvoltage spikes, excessive currents).

If you can get connection using fiber optic cable, I recommend using it instead of copper. One of the key advantages to fiber optic cable over copper cable is immunity to ground problems and overvoltages. Since fiber is glass, there is no metal contact and therefore, no ground problem. Unfortunately to convert to fiber means usually buying an extra box for each output and each input, a significant added expense.

Sources

This article is based on [The Cherry Juice Issues Online: MAY CHERRY JUICE 1999](#) article GROUNDING and it is updated and made more accurate with my own knowledge and experiences.

[Tomi Engdahl](#) <Tomi.Engdahl@iki.fi>

ePanorama.net

[[index](#)] [[back](#)] [[site search](#)] [[acronyms](#)] [[discussion](#)] [[post message](#)]

We are sorry...

...but the URL you are trying to access could not be found or is not available any more.

Please check the URL, proceed to [our homepage](#) or use our [search functions](#) to find the information you are looking for.

[[webmaster](#)] [[feedback](#)] [[main](#)]

Building your own antenna isolators

Antenna cable isolator is basically quite simple circuit but it must be built correctly. Improperly built antenna isolator can cause RFI problems and even screw up the building antenna network operation. Antenna isolators work at very high frequencies (up to 500 MHz) where even a very small construction details and component specifications can have a high difference on circuit operation. If you are not experienced and knowledge at building high radio frequency circuits, I recommend that you buy a ready made isolator instead of try to build it yourself.

Build your own antenna isolation transformer

Best solution to antenna/cable caused ground loop is to add a 1:1 transformer in the antenna signal, floating the VCR with respect to the cable tv ground. This solved the hum, no need for a messing with the audio signal, and the tv image quality did not suffer (most tv's get an overdose of signal from the cable tv anyway).

You can simply make such a 1:1 transformer:

- Take two strands of insulated wire, length: 10-20 cm.
- Twist the two wires, about 1-2 twists per cm is enough.
- Next you need a small transformer core suitable for UHF frequencies. I used a donut shaped ferrite core. Try looking in an old TV or radio. Wrap the twisted wire a few turns around the core.
- One wire is the primary winding, the other the secondary (so it helps to color code the wires).
- Make the leads between the coaxial antenna plugs and the core as short as possible.
- You're making a transformer, i.e. if you have a red and a blue wire: connect the blue ends to one antenna plug, and the red wire to the other plug - not two colors on 1 plug.

For tv frequency signals such a simple transformer (using a suitable core) is almost perfect. Do not try to use other types of transformers because your circuit would not work then and they would cause annoying interference to other TVs connected to same antenna network (and in worst case you get cable TV people hunting for you because you messed with their cable network).

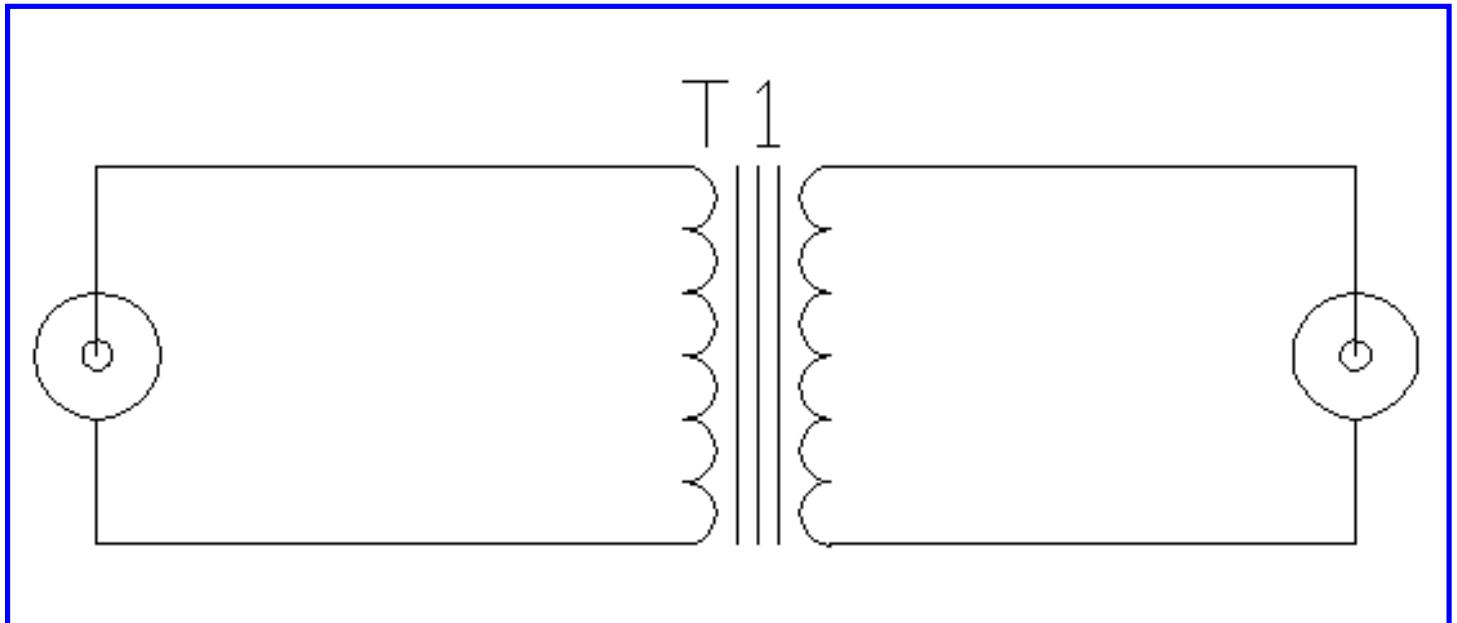

I have seen another transformer circuit posted in the usenet. Kari Hautanen wrote an article to sfnet.harrastus.elektronikka newsgroup about antenna isolator. The article says that you can build a suitable transformer using following method: Primary and secondary are three turns of 0.2 mm Cu-wire wrapped around small magenta coloured toroidal ferrite core. Seems quite simple, but the article did not mention the exact core size. It mentions the source of the circuit to be a book Osmo A Wiio, Reijo Laine, Radioamatöörin käsikirja, EU Harrastekirjat 1978, 1980, page 164. I have not been able to

locate the book to check the circuit, but the circuit in one ready-made isolator had very similar circuit:



On the picture above you see the whole " J A-A Junction häiriöadapteri" adapter from [Suomen Radioamatööritarvike Oy](#). The picture below is close up picture of the details inside the antenna isolator adapter:



It had three turns of thin wire in primary and secondary wrapped around small ferrite core. The wiring inside the isolator is very similar to the audio isolator circuit, the only difference is that now connectors are antenna connectors and the transformer is the one designed for antenna signals (described above). The thin wires between the transformer and the coaxial cable are kept minimum to avoid the adapter to pick up interference.

If you live in Finland, you can buy this type of isolation adapter from [SUOMEN RADIOAMATÖÖRITARVIKE OY](#) under name J A-A Junction häiriöadapteri television. It costed 43 mk when I last checked the price (about 9 US dollars).

For more ideas how to fight against ground loop caused by cable TV connection, check the [Fixing Cable-TV Hum in Audio Systems](#) article by [Jay Rose](#) at <http://www.dplay.com/tutorial/cablehum.html>. [Secrets of Home Theatre and High Fidelity](#) web magazine reviewed an antenna wire ground loop isolator product [UNHUMMER](#), so read the [article](#) if you are looking for an isolation device suitable for antenna network which is used in USA.

Simple two capacitor isolator

This circuit is a simple isolator for TV and Radio antenna connection. This circuit passes radio frequency signals nicely, but does not pass significantly 50 Hz signals, so the ground loop is eliminated. The circuit can be easily built into antenna connector or to a small box. I would recommend to use small metal box, where you connect one of the antenna connectors to the metal box and isolate other connector from box. Metal box allows mechanically strong construction and provides good shielding against radio interference. The capacitors in the circuit should be rated at least 250VAC (400V DC) to make sure that the adapter with stands situation when antenna network of television/radio is floating at mains live potential.

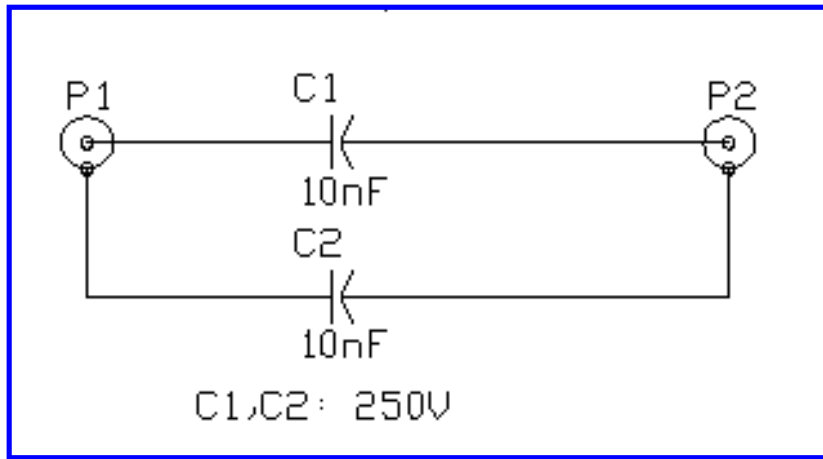

There is one disadvantage of this the circuit breaks the continuous shielding of the antenna cable which makes you antenna cable pick up radio interference more easily (for example radio interference picked by ground loop itself). Usually this is no big problem, but if you notice severe interference then you might have to stop using this isolator. The best place to put this isolator (to keep possibility of interference minimum) is just between TV receiver and antenna cable going to wall.

This capacitor isolator scheme might feel quite strange at the first sight, but it actually works and cuts the ground loop because it provides high impedance to low frequencies (50 or 60 Hz mains frequency) but has low impedance at the RF frequencies that are used at cable for TV channels. To eliminate the hum, you must insert a high impedance at 60 Hz. between the cable, its shield, and the audio-video system and at the same time provide a low impedance path for RF signals. The lowest signal frequency, for which the impedance must be very low with respect to the 75-ohm cable impedance, is around 50 MHz. That is about 1,000,000 times higher than 50 Hz. A 10 nF capacitor has an impedance of less than 1 ohm at 50 MHz and over 200 000 ohms at 50 Hz. Therefore, isolating the cable's center conductor and shield each with a 10 nF capacitor from the input to the cable tuner will eliminate the 60 Hz ground loop current and resultant hum without attenuating the RF signal level.

Capacitor isolator approach is an old trick used in TV industry. When the old TVs had their chassis at mains potential, they used this kind of approach to make sure that the dangerous voltage can get to the cable from the TV but the RF signal goes nicely to TV. Isolator used in one old TV had 330 pF 500 VAC capacitor which connects the center of the coaxial cable to tuner and the shield of the coaxial cable was connected to TV chassis through 820 pF high voltage feedthrough capacitor (value unknown).

A commercial isolator which plugs to TV cable made by JEBSEE uses 11 nF capacitor for connecting coax cable center wire and 22 nF capacitor to connect the shields together.

The easiest way to build the isolator is to use two chassis-mount antenna cable connectors (typically EIC antenna connectors on Europe and F-connectors on USA). Connect the center pins with one 10 nF capacitor and use the connectors' mounting nuts to connect a second 10 nF capacitor between the bodies, making sure that the connectors don't touch. You can then wrap the center with tape or put heat shrinking plastic tubing on it. This construction is a little flimsy but it won't get any stress, and the leads will be shorter than if you used a plastic box to mount the connectors, thus reducing the possibility of picking up RF interference. When constructing the circuit remember to keep all the component leads very short (remember that you are dealing with very high frequency RF signals which can easily radiate out of circuit on even quite short wires and those wires can pick up interference as well. or use a very small plastic box for the whole circuit.

Transformer isolator using two baluns

There is an alternative approach to antenna isolation problem: use transformer as in audio lines. The problem is to how to make a good transformer for antenna signals. If the transformer causes impedance mismatches, this can cause signal reflections which disturb you and maybe your neighbours also.

One way to do it is to use readily available 75 ohm to 300 ohm transformers (called "baluns" or "matching transformers") used when connecting old televisions with 300 ohm antenna input to modern antenna network with 75 ohm connectors. Those units are readily available from TV shops.

Notice that some 300/75 baluns are true (isolated) transformers, while others have a common ground. You can use the former type to break a CATV ground loop, but not the latter. So be sure to buy models which have no galvanic connection between 75 ohm input and 300 ohm output (so there is isolation between input and output), because some models only do impedance matching but galvanic no isolation (they are useless in this project). If you use an ohmmeter between the input and output you will find that there is a very low resistance between *all* the terminals if there is no isolation and open circuit if the balun transformer provides galvanic isolation.

The circuit is easy to build. Just take two of those 75 to 300 ohm antenna transformers and connect their 300 ohm sides together. Now you have antenna isolator you need.

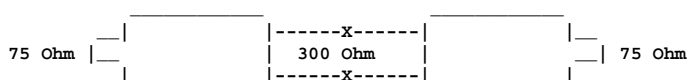

This circuit has been suggested by Paul Grohe (grohe@galaxy.nsc.com), who suggested that suitable transformers are available from Radio Shack (Radio Shack cat. #'s 15-1140 and 15-1253 or MCM #33-050 and #33-010). [LiveDV magazine](#) suggests using Radio Shack #15-1140 and #15-1523 antenna transformers wired together in their Soundings: Getting Wired tutorial (January 1996). According some comments I have recieved some people have pointed out that the not all Radio Shack 75-300 baluns are not isolating, so the above circuit might not work as epected. I don't have access to those component from Radio Shack, so I can't check what is the real situation. I have received mixed message on both failing to get the circuit to work as expected (no isolation) and some that the circuit works well ((Radio Shack cat. #'s 15-1140 and 15-1253). It is hard to say for sure what is the problem (could the product with same code vary in this sense though product code staus same). It is best to test by outself that the baluns you plan to use are really isolating. If the balun is isolatating can be tested with multimeter: measure the reistances between all input and output pins. If there is no conenction found between input and output, then this balun is suitable for this circuit.

If you experience radio interference picked by this circuit, you can can try the following method to make shilding ogh the circuit better: You can wrap the whole little assembly in aluminium foil and ground the foil to the "cable" cable shield. But don't let it touch the other ground.

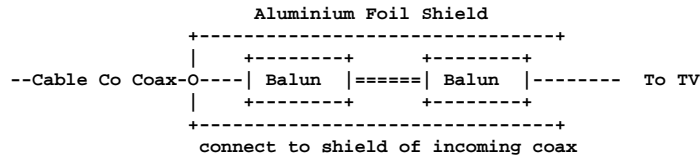

[Tomi Engdahl](#) <Tomi.Engdahl@iki.fi>

Ground loop problems in video lines

What ground loops do to video lines

As the source and destination of a video signal can be at differing ac or dc earth potentials, earth loop currents flow and cause longitudinal hum to be introduced into the video signal. Video hum is low frequency (50 or 60 Hz mains frequency or it's harmonics) noise from the ground lines which has influenced the video signal, causing degradation of the displayed signal. Video hum is usually observed as bars rolling vertically through the video image, video hum may also cause video distortion or even tearing of the picture in severe cases. Video hum may be a problem in any system where video sources and display devices are connected to different A/C power sources with varying grounding potentials.

Typically the humming can be seen as slowly vertically moving horizontal bars in normal TV video signals. The same kind of bars can be also seen in computer screen, but typically they are not as visible because bars are moving so fast that you see them as some strange flashing in screen.

The picture below is a real world example of the effects of a ground loop and what it causes a a video picture received from the cable TV network:



As you can see that video signal has strong humming bars and other interference in it. Those have entered the cable TV signal because of ground loops in the system. Ground loops in the video systems can have following effects:

- Hum Bars: The mains frequency (50 Hz or 60 Hz) can cause stationary or moving horizontal humming bars to appear on the video signal (as shown on the picture above). If you have light dimmers nearby those humming bars can easily become quite severe and easily visible.
- RF Interference: Herring bone interference on video line is caused by a ground loop (that includes your coax shield) acting as an AM radio antenna. Any large loop of wire makes a good AM antenna. These antennas are especially adept at picking up AM broadcasts if most of the loop is vertical.
- Cross-Talk: Ground loops can cause one signal to interfere with another, because every cable should ideally return through the corresponding shield conductor, but there's an alternative path through the other shield conductor which causes undesirable voltage differences to nearby cables.

Ground loop isolation in video lines

Isolating video signal is more complicated than isolating audio or antenna signals, because the DC level of the video signal is important and video signals have very high frequency spectrum (normal composite video can have bandwidth from 50 Hz to 6 Mhz).

Isolating video signal needs typically active technology which involves electro-optical isolation or differential amplifier with a floating ground on the input connector. Those both technologies are usable in real world situations. Differential input with floating ground works nicely for small ground potential differences and this approach is used in some professional video equipments (some video projectors I have seen have had differential inputs and option to disconnect input ground connection). Differential inputs are also used in applications where a video signal is transmitted through twisted pair wiring (some CCTV applications which use twisted pair interfacing equipments).

Electro-optical isolation works well in applications where complete electrical isolation is necessary. There are some this type of isolation devices on the market and some special video distribution amplifiers have this kind of option built in.

Ground loop elimination does not always ask for a complete isolation of the grounds. There are passive hum suppressor transformers which will very effectively remove the hum from the video signal (typically around 40 dB hum level reduction), but do not effect the video signal otherwise. Those special transformers act like a common mode coils, which stop the annoying ground loop currents on the shield of the coaxial cable, but provide a straight path for the signal inside the cable. This kind of devices are capable of passing the signals from DC to tens of MHz without problems. This type of hum suppression transformers have found their way to the professional video application (rental companies) and computer video applications (computer to video projector connections). The transformers of this type are usually called "hum bug transformers", "humbucking transformers", "anti-hum video transformers" or "hum suppressor transformers". Generally term hum-bugger refers to any circuit (often a special coil) that introduces a small amount of voltage at power-line frequency into the video path to cancel unwanted ac hum.

There are also special wideband isolation transformer which can isolate video signals. A transformer which can nicely transfer the whole video frequency spectrum without much distortion is very hard to produce so there are not many of them on the market. Some of the isolation transformers are only designed for CCTV application, where more signal distortion is accepted than in broadcast industry.

The choke (humbucking transformer) is primarily used in Broadcast TV because it passes the DC component of the signal. It is used in studio, and in remote ENG. The isolation transformer is primarily used in CCTV: security, manufacturing, avionics, display, etc.

Differential video amplifiers

Differential amplifier approach uses an operational Amplifier. Operational Amplifiers only amplify the difference between the two input lines. This method eliminates common mode noise between the incoming signals by making $A-B=C$, as only the difference between A & B are amplified. Operational amplifiers maintain wide bandwidth signals throughout your system while eliminating ground loop problems that are caused by power and video. Differential video amplifier inputs are used in some video equipments (typically some video projectors) and video distribution amplifiers to fight against ground loop problems.

Differential video amplifiers have a limitation on their input voltage range which gives some limitations how much common mode signal those circuits can tolerate. If the ground potential difference is more than few volts, then operational amplifier based isolators don't work effectively. Too high voltage difference can cause problems from very distorted video signal to damaged differential video amplifier. If the voltage difference is a substantial proportion of the DC supply voltage of the amplifier, you will probably have trouble using an amplifier alone.

It is a good idea to measure the voltage difference before using differential video amplifiers to be sure not to damage them. Measuring can be done using a multimeter (check using both AC and DC ranges) or better using a scope earthed to the mains supply, and put the probe on the earth connection of the incoming video cable. If you many potential difference which are many volts, then you have quite probably something wrong in the grounding of the building and you should consult a qualified electrician to check and correct this potentially dangerous problem.

Good back porch black level clamp

If the video signal input has well designed fast black level clamp circuitry that can also solve small common mode noise problems caused by ground loop. Back porch ground level clamp circuit adjusts the black level of the video circuits according to the incoming video signal. If black level clamp circuit is active circuitry which samples the black level separately for every scan line the ground loop bars are quite effectively eliminated because the low frequency noise (50 Hz power or harmonics) is sampled at start of every scan line and suppressed then from the rest of the line. This works quite nicely with those low frequency humming bars, especially if combined with differential video inputs. back porch black level clamp system does not help in fighting against higher frequency noise which might be injected to the video system through the ground loop.

Active video isolators

Video Isolator passes a video signal from its input to its output with no electrical connection and is able to provide complete isolation, for the video signal, passing through it. Having the Video Isolator in the video signal path makes it possible to have Standard Safety earthing of all equipment with no associated earth loop problems. In the studio, feeds between different buildings are no longer a problem and it is no longer necessary to run technical earth to non critical locations such as viewing rooms.

Electro-optical isolators convert video signal voltage to blinking LED and other part of the circuit receives that light and convert it to back video

signal voltage. This method guarantees very good isolation (complete galvanic isolation), but has typically bandwidth and linearity problems. Poor bandwidth will result in fuzzy images and poor linearity will result in an inability to produce the same gain for all signal levels (most noticeable in gray-scale patterns).

Anti-hum video transformers

Anti-hum video transformers are not real transformers, they are common mode chokes! Anti-hum transformers work as a series inductor offering a series impedance to the circulating earth currents thus effectively reducing the current flowing in the loop which will reduce the voltage drops on the cable shields and equipment (that reduces hum). Those coils can reduce the currents on cable shield very effectively because they have very high impedance at 60 Hz and above and therefore presents a high impedance to common mode signal differentials between the input and output. Earth loops typically have low resistance a quite the inductance will not have to be very huge to start to help. The coil itself will then have quite much voltage difference on the input and output grounds (the potential difference is now over the transformer instead of distributed to whole cable), but the common mode coil construction guarantees that this difference is not coupled to the differential signal inside the cable. Since the signal and ground lead are coincident, the differential signal is unaffected.

Hum reduction transformers or common mode coils are constructed with either 75 Ohm twisted pair (made of fine wire) or coaxial cable wrapped around a very high permeability core. Most basic hum isolation transformers are basically just coax cable wound on a toroid-type core. They work by mutual inductance. The coax cable is wound around a transformer core so that both the inner and shield of the cable become inductors. The tight coupling ensures that any voltage in the shield caused by variations in earth potential are transformed into the inner conductor.

The method is an ancient idea and can cope with very large ground loop signals, and has very large bandwidth with very little loss. This type of anti-humming transformer also provides DC continuity between the input and output leads which is a good thing. transformer does not stop ground loop current flowing (the amount of current is lower because the added inductance) but the transformer reduces the current cancel the effect of ground loop current. Good one can reduce the ground loop effect up to 40-50 dB.

Hum isolation transformers are effective solutions for hum problems. The downside of them is that they are somehow bulky devices because of the large core needed to do the job. The boxes I have seen have been packed in metal case have weighed at least one kilogram. Hum isolation transformers are typically stand-alone passive boxes which are added to video system when problems are encountered.

Video isolation transformers

There are special wideband isolation transformer which can isolate video signals, but not without problems. The design of a high bandwidth transformer which can go to very low frequencies is very hard. You have to always make some compromises on low and high frequency responses (highest components of composite video can be attenuated even few dB). All real isolation transformers have one serious drawback which can't be avoided: they can't pass the DC level through. So any system that relies on the video having any particular DC reference will not function properly. There are many video systems around which need particular DC reference level, but there are many which are AC coupled.

Some of the isolation transformers are only designed for CCTV other not so demanding applications application, where more signal distortion is accepted than in broadcast industry. So a video isolation transformer might be OK for a security camera installation if a complete isolation is needed, but I would not put it on any professional video studio system.

More information

[Extron Electronics](#) has a good articles about video cabling ground loops their web site. Those documents are really worth to look at.

Commercial video ground loop problem solution products

Here is a list of products I have seen on the web to reduce video hum. I have not tested any of those products.

Active devices

- CVDA 6 MX - one input, six output isolating composite video distribution amplifier from [Extron Electronics](#)
- Hum Nulling Video Distribution amplifiers from [Video Accessory Corporation](#)
- [Kramer Electronics OC-1N Optic Ground Isolator](#)
- [Multidyne VPDA-100](#) - distribution amplifier with back-porch clamp for hum cancellation
- [Practel GA-409 Isolating video amplifier](#)
- [HBVB/VDA Video Brick Humbucking Video Distribution Amplifier](#)
- [VL-2 Video Line Isolator](#) from [Video Accessory Corporation](#), provides 1500V (peak) isolation with optional audio isolation

Passive devices

- [ADC HUM-1](#)
- [Allen Avionics Video Hum Eliminators and Video Isolation Transformers](#)
- [Anna Valley Electronics](#) TYPE 2000 ISOLATOR - four separately isolated inputs, suitable also for computer signals
- Brick Distribution Amplifiers with differential input from [Video Accessory Corporation](#)
- [Deerfield Lab wideband isolation transformers](#)
- [ES 3230 decoupling video transformers](#)
- GLI250 Ground Loop Isolator - 250 MHz ground loop isolator for workstation video signals from [Extron Electronics](#)
- [Humbug](#) - video isolator from [Tecton](#), provides 600V isolation
- [Inline Inc. IN2062 / IN2063 RGBHV / RGB Hum Suppressors](#)
- [IN2062 / IN2063 RGBHV / RGB Passive Hum Suppressors](#) from [Inline Inc.](#)
- [Jensen Transformers](#) - company which makes video isolation transformers, for example [Iso-Max VB-1RR](#) and [VB-1BB](#)
- [North Hills Signal Processing Video Isolation Transformers and Humbucking Transformers](#)
- [Steven & Billington Limited Video Isolation Transformer](#)
- [Telecommnect Ground Loop Transformer](#)
- [Video Hum Stoppers](#)

[Tomi Engdahl](#) <Tomi.Engdahl@iki.fi>

Networked computer equipments and ground loops

Power-related problems were the number one cause of computer downtime (according studies conducted by Contingency Planning Research and Stratus Computer 1994). Many of the power-related problems can be traced to the most basic element of the computer network: The wiring and grounding of the host building.

Majority of today's networks are still attached via a copper-based medium. This copper wire can be the path for disruptive and potentially dangerous current and voltage events.

Typical effect of power related problems are from intermittent reboots or lockups to spark-producing power supply damage. Network interface cards, serial ports, parallel ports and modems are all prime targets for destructive power events.

Governing standards (in USA)

In the opening page of the National Electric Code (NEC) states that the "purpose of the Code is the practical safeguarding of persons and property from the hazards arising from the use of electricity." The Code further states that the "Code contains provision considered necessary for safety. Compliance [with] will result in an installation free from hazards but not necessarily efficient, convenient or adequate for good service."

The Institute of Electrical and Electronics Engineers (IEEE) has published **IEEE Standard 1100-1992: IEEE Recommended Practice for powering and Grounding Sensitive Electronic Equipment**. The main purpose of the standard is to present "recommended engineering principles and practices for powering and grounding sensitive electronic equipment.". The standard attempts to provide a consensus about what specific installation practices should be used to afford electronic equipment maximum availability.

In all areas the IEEE specifications are more stringent than those contained in the NEC.

Shared neutral problems

Non-linear loads do not draw current in phase with the voltage waveform. This causes distortion and harmonics to current waveforms. As the result of this the currents sent back to the source in neutral wire is additive (the currents do not cancel each other like the case in neutral load case). NEC allows multiple circuits to share a common neutral wire which can lead to overloaded neutral wire if all the circuits are loaded fully with non-linear loads. IEEE standard 1100 specifies the need for dedicated circuit for computer equipment and neutral conducting impedance and sizing requirements.

Use of the conduit as ground

According NEC the conduit or piping that electrical wires is run is allowable as "ground." IEEE standard 1100 recommends that "electronics loads be grounded with separate equipment grounding conductor" and this equipment grounding conductor must be "insulated from the conduit ground."

"Isolated Ground" wiring practices

Isolated circuits were supposed to solve the grounding issues faced by today's computer equipment. In reality the installation of those those circuits is seldom done correctly. The NEC gives very little details about installing the isolated grounds where IEEE Emerald Book gives specific procedures for installation and maintenance of isolated ground circuits. The users of computer systems are suffering this discontinuity between IEEE and NEC guidelines.

Finding the power problems

The on-site work required to find the problem usually starts at the computer equipment under question and works backwards through the electrical

distribution infrastructure. Branch circuit are examined for total harmonic distortion (THD), conductor resistance, rms voltage and grounding methodology.

Pay attention to mains connections of connected equipment

Every desktop PC has its cover, as well as the ground pins, connected to the center wire of the mains plug ("protective earth"). If you have two PCs connected to different mains plugs that you intend to connect together, it is possible that each of them is connected to a different branch of your home electrical wiring. Although these are connected together at the switchboard, they may have different voltages if a heavy load is connected to one of them (e.g. washer, dryer, etc.) causing a voltage drop. Single pulse can reach the order of tens of volts. This voltage difference then appears at the inputs of the PC, EASILY DESTROYING the parallel or serial port, hard drive controller, sometimes even the whole mainboard. Therefore, it is a good idea to connect only PC's powered from the same mains plug, or at least connected by a single extension cord. The same applies to monitor, printer and other connections.

Recommendations on grounding in computer networks

Nowadays the shielded LAN cable is becoming common. Shielded cable become grounded in every connection point (both ends of the cable). In this kind of system it is essential to keep the the ground potential difference very low in the whole network area.

Every cabling rack in the distribution points must be grounded to the main grounding bar using a separate ground wire. The electrical system ground must be also very good and at the same potential as the central grounding bar. It is essential to keep the active elements (HUBs, LAN switches, routers) at exactly the same potential as the rack cabinet.

The resistance from any grounding point to the central grounding bar must not me more than 1 ohms and the voltage diffeerec must be less than one volt. The resistance between the workstatio mains power ground in the network cable ground must be less than 2 ohms. In order to keep the grounding resistance low the grounding cables must be thick enough.

In unshielded twisted pair cabling the ground potenatial differences are not as critical as in shielded cabling, but it still a good idea to keep the ground diffeences minumum to guarantee reliable network operation. Especially the grounding of the equipment racks and the active network equipments must be good.

Sources

- Tony DeSpirito, Networking Equipment And Downtime: Caught In The Middle, Electronics Design, April 1, 1997, pages 42-48
- Harri Kosonen, LAN-vianhaku osa 1: LAN-mittarit ja työkalut, [Proessori](#), 8/1998, page 32

[Tomi Engdahl](#) <Tomi.Engdahl@iki.fi>

Ground loop isolation in data networks and interconnections

Isolating serial data lines

When you have two computers in different rooms connected together using long RS-232 wiring you can face ground loop problems. Isolating RS-232 line communications is harder than those audio or antenna connections. The best solution to solve those ground loop problem is to buy a commercial equipment which is designed for this kind of purposes. There are [RS-232 isolators](#), current loop converters and short distance modems which can do the job. [B&B Electronics](#) has a very good data sheet collection (including schematics of many products) available on their web site. They have also very good [RS-422/485 and Current Loop application notes](#) available on their [technical library](#).

Ethernet networks and ground loops

Ground loops in [Ethernet](#) networks can cause network not to operate properly and other annoying ground loop problems.

Thick Ethernet

The thick coaxial media system was the first media system specified in the original Ethernet standard of 1980. Today most sites use twisted-pair media for connections to the desktop. Thick coaxial segments are still sometimes installed as a backbone segment for interconnecting Ethernet hubs, since thick coaxial media provides a low-cost cable with good electrical shielding that can carry signals relatively long distances between hubs.

An Ethernet interface is attached to a thick Ethernet segment with an external MAU. The MAU provides an electrical connection to the thick Ethernet coax and transfers signals between the Ethernet interface and the network segment. The MAU is powered from the Ethernet interface, but all signal lines coming to the MAU are electrically isolated in the ethernet card.

The standard notes that the thick coax segment should be grounded at one point for electrical safety reasons. There must only be one grounding point, to avoid disrupting the Ethernet signals carried by the cable. All other metal parts on the cable should be insulated or carefully routed and fastened in place with plastic cable ties to avoid accidentally touching an electrical ground. If the components and cables connected to MAU are properly isolated from nearby grounded metal parts, the system is ground loop problem free.

Thin Ethernet

Thin Ethernet (10Base-2) uses coaxial cable which goes from computer to another. That cable should be grounded from one end for safety reasons. That cable is electrically isolated from the computers at the ethernet card. The cable shield be accidentally and easily get in contact with the metal case of the computer if the metal connectors in the cable touch the metal case of the computer.

To avoid this kind of problems it is a good idea to use connectors which have plastic isolation over them or install a plastic isolation around them. Make sure that you don't have any metal connectors or broken cable shields touching the metal wiring conduit.

Twisted Pair Ethernet

10Base-T Ethernet used twisted pair wiring and RJ-45 connectors. The wiring is completely transformer isolated in network card and HUB end. 10Base-T network using unshielded twisted pair wiring does not cause any ground loop problems. If you are

If you are working in environment where ground loops are very problematic then 10Base-T network using unshielded twisted pair cables is one of the

the safest choices. It can cost a little bit more but is very flexible and you will save very much in long run in network trouble shooting costs.

The same which applies to 10Base-T applies also to 100 Mbit/s Ethernet which used unshielded twisted pair wiring (100Base-TX).

Fiber optic links

If you use Ethernet cabling with fiber optics, those fiber optics links are free of ground loop problems, because the systems on the ends of the cables are optically isolated from each other by the long optical fiber between them.

MIDI

MIDI interface is designed for controlling musical equipments and the possible ground loop problems in audio systems are taken to account. MIDI interface is designed so that the interface is isolated in the receiving end so that it does not make ground loops if wired correctly.

[Tomi Engdahl](mailto:Tomi.Engdahl@iki.fi) <Tomi.Engdahl@iki.fi>

Published by ELH Communications Ltd. all rights reserved.

Isolatings mains power in laboratory enviroment

Recommended practices

Mains power isolation in laboratories is mainly done for safety reasons, not for fighting against ground loop problems. The mains powered electronics devices which are being repaired are connected to mains power through isolation transformer to make it safer to test them.

A general recommended practice for electronics device repair shops in Finland is to use at least two mains isolation transformers in their repair environment. The first one is an isolation transformer which isolated all the test equipments (like oscilloscope) from the mains ground and the other one is the one used for isolating the equipment which is being tested or repaired. This arrangement is very good on both safety and noise reasons.

Sometimes isolation transformers are also used to fight against noise problems, but generally they are used for safety reasons in electronics laboratories.

Mains isolation transformer does not always help in groundloop problems

It is sometimes suggested that an isolation transformer might be used to solve the ground loop problem. It is true, that sometimes a mains isolation transformer does help, but not always.

The reason that mains isolation transformer will not always work is that there is quite a variety of mains isolation transformers designed for different uses. Those mains isolation transformers all isolate the main live and neutral wires, but vary what they do to the ground connections. Some transformers cut the ground connection to mains ground, some other doesn't.

For example international office product safety regulations including IEC 950 and UL 1950 require that an isolation transformer is only allowed to isolate the hot and neutral wires; the grounding wire must be passed straight through. Since the computer circuits including data communication circuits are connected to the grounding wire and not the neutral wire, the isolation transformer or any power conditioner or UPS with an isolation transformer has absolutely no effect on computer grounding problems.

For laboratory use there is available special isolation transformers which also isolate the ground connection (at least in Finland). This transformer provides complete isolation of live and neutral wires. The output can be non-grounded electrical output because the transformer provides adequate isolation. Remember that you are generally allowed to connect only one equipment to this kind of safety isolation transformer. If you connect more than one equipments to safety isolation transformer, you can create a potential hazard. This kind of transformer is good laboratory environment, but it might not be considered safe or not meeting the electric code outside laboratory.

[Tomi Engdahl](mailto:Tomi.Engdahl@iki.fi) <Tomi.Engdahl@iki.fi>

Design tips for balanced audio connections

Balanced connections does not automatically guarantee hum free connections, but well designed balanced connection avoid problems in very many cases. Unfortunately there are many equipments where the balanced connections are not designed well, so they do not perform as well as you would expect them to do.

Grounding of inputs and outputs

The grounding of audio cables have

Grounding in balanced audio connections

It is absurd that you cannot go out and buy pro audio equipment from several different manufacturers, buy standard off-the-shelf cable assemblies, come home, hook it all up and have it work hum and noise free. Use only balanced lines because they were developed to provide good isolation against external interferences. Tie the shield to the chassis, at the point it enters the chassis, and at both ends of the cable. Standard XLR cables come with their shields tied to pin 1 at each end (the shells are not tied, nor need be), this means equipment using 3-pin, XLR-type connectors must **tie pin 1 to the chassis** (usually called chassis ground) not the audio signal ground as is most common.

If the grounding od XLR pin 1 is done correctly in the equipments the currents running in the cable shield easily cause humming inside the equipment electronics. This has lead to a situation that not using signal ground is a common practice in pro-audio practice. This is not a good solution to the problem.

Design rules used in professional audio equipment design

Audio-frequency groundloop problems are typically in the low millivolt range. As a general design rule, true professional equipment designed for the real world of Pro Audio should not have its mains/chassis ground and electronics ground permanently and directly connected. It should either be totally isolated / switchable or have the chassis and electronic ground connected via a soft coupling resistive/capacitive network.

Signal balancing

Good balancing of the signal is absolutely necessary for the balanced inputs to work as expected. Balancing means that the inputs and outpus use different signals, but that's not all. Balancing also means that the cables are impedance balanced: both wires in the pair see the same impedance. The impedance balancing is absolutely necessary for reliable operation in real world situations. If the impedances are not properly balanced the equipment might give good CMRR figures on typical test bench measuring setup but perform quite poorly on real-world situations.

In the sending end the baöancing is easy to use. Just match the output impedances of the output amplifier stages by using same size output resistor for both inverted and non-inverted outputs.

For baöanced inputs you must select a differential input circuit which really shows the same impedance to both inverting and non-inverting inputs. Quite many basic differential amplifier schematics show different imepdance values to those input. So be careful in the design process and analyze the input impedances carefully.

Floating transformer inputs and outputs are also a good way to do the impedance balancing. Floating input and output will be automatically balanced if a good audio transformer is used.

Ground loops and equipment design

Ground loops are not only a problem in connections between equipments. When you design electronics circuits you should always avoid causing unnecessary ground loop, because they cause many annoying problems. A typical problem when the grounding is not done properly is that the electrical noise from the noisy parts of the circuit gets to the parts of the circuit which should be free of noise. Here is some guidelines for designing grounding systems used in equipments:

System part interconnections

When you have two circuits that are tied together electrically, but one of them is high current then you should direct the ground and power paths to "feed" them separately. You want the current of the driver to stay on the driver side and the current of the logic to stay on it's own side. The thin trace inbetween is still needed because this is not galvanic isolation.

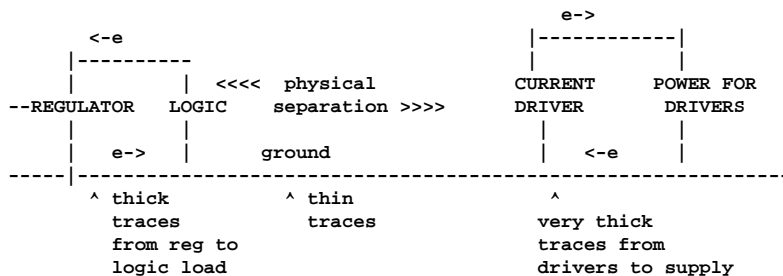

The common mistake is to "daisy chain" the ground by having the ground of the high current item seek it's current path through the ground of the logic. This causes ground spikes on the logic and thus logic errors due to bad voltage levels at the logic chips.

Physical separation is to prevent electromagnetic coupling, of course. Even getting the grounds proper won't help if you couple the magnetic field back into the logic traces.

Always image traces to be resistors. Thick ones are small resistance and thin ones are large. The objective in laying out the board is to encourage the large currents to take the path back to their own source without getting onto the other grounds.

Separating current paths in this way can make a micro run right along side of a vicious current driver and not have logic problems in most cases. The cases in which it usually doesn't work is when the signal being sent to the driver is analog instead of digital. You're going to get some amount of ground differential with the separate ground paths and so the analog signal will reflect this difference in the signal voltage relative to ground.

Current loop coupling of the signal to the driver could solve a really bad problem of ground differentials, but I have never used that technique. If your going to go to that extreme then you may as well isolate them altogether.

If your signal is digital you can clean it up abit by having a schmidt trigger on the driver side of the loop with it's ground relative to the high current load. This can provide a volt or more of tolerance in the ground difference.

If you get the currents going right you will see less problems with the logic side, but you might see more problems with the driver because it's signal from the logic is corrupted by lifting of the ground potential because of the high currents. When you have reduced this effect by minimizing the high current ground ohmage to the point where you can't minimize it any more AND you have included schimdt buffering, then it's time to admit defeat and galvanically isolate the two circuits.

When you have power electronics and some microelectronics on the same circuit the layout of the current loops is critical. This also applies to situations where you have microelectronics and audio circuit on the same board.

What are the problem with treating both digital and analog grounds as the same ground source ?

Your digital circuit noise can get to your analogue signal path if you don't use separate grounding systems for digital and analogue parts (those are interconnected only in one place). Digital grounds are invariably noisier than analog grounds because of the switching noise generated in digital chips when they change state. For large current transients, PCB trace inductances causes voltage drops between various ground points on the board (aka "ground bounce"). Ground bounce translates into varying voltage level bounce on signal lines. For digital lines this isn't a problem unless you cross a logic threshold. For analog it's just plain noise to be added to your signals.

How to eliminate this problem ? why the suggestion of keeping analog and digital grounds separate is made by having them separate on the IC, so use separate grounds. Two completely separate supplies allows switching currents to be speced and optimized for at the regulator, and to have analog supply optimized to be nice and quiet. Filtering and bypassing can help to short out some ground bounce currents. And if you connect the analogue and digital grounds together do it only in one single well-designed place.

If you are building an analogue to digital converter circuit, then you have to be very careful in keeping the analogue and digital grounds separate or otherwise you will not get the resolution you expect to get because of the noise. The AGND and DGND pins should connect to the analogue ground, preferably with it flooded under the whole IC package. If you don't do this, noise on the DGND pin from the digital supply will get injected into the analogue section inside the IC. Decouplers should be placed close to the AVDD pins (analogue supply), which connect to the analogue supply plane. In order to stop noise being introduced to the analogue plane OR being injected into the analogue section of the chip from the DVDD pin, the DVDD pin should be connected to the analogue supply plane via a small filter, such as a ferrite bead, depending on the application and frequencies of interest. Make sure the decoupler for the DVDD is located close to the pin, with the bead not much further away.

The digital input lines should be close to each other and connect to the nearby digital IC. Underneath these lines, the analogue and digital ground planes should CONNECT. The reason for this is to keep the radiating loop area of the digital current path to a minimum. If you don't do this, every time a digital edge occurs, the pulse will either flow around rather a large path or get injected into the IC's analogue section, depending on your implementation. If your analogue side voltage needs to be very stable it needs its own regulator. Look for low-noise regulators, such as the ancient LM723. Other designs may find the digital supply regulation adequate and so just use an inductive filter to remove the necessary frequencies.

Why some circuits have separate analogue and digital grounds ?

Separating analogue and digital ground generally has to do with return currents and ground noise. Even though we think of GROUND as having zero impedance, it is a wire like anything else. Even ground planes have some impedance, and so currents flowing through these grounds cause voltage drops in the planes.

If we have a circuit that is operating on a sensitive analog voltage levels, or frequencies, we might not want these unexpected voltage drops occurring in the circuit. They are often injected into the circuit by filter caps, or bypass caps that were placed into the circuit to filter a signal or chip. So, the best way to keep this noise out is to create a separate analog ground.

Separate grounds does not always mean totally separated. Most analog ground and power splits are done by either just isolating the plane and not allowing the digital signals to flow over it. There is generally a single point connection between the DIGITAL and ANALOG grounds. More than one point opens up the possibility of ground loops which cause the ground noise from the digital side to enter to your analogue electronics ground.

You should not run digital signals over or directly next to your Analog signals or planes. This will result in capacitive/inductive coupling to the "quiet" Analog planes, and/or result in horrible signal quality on the digital signal as its return current (which normally returns on the plane directly below the signal) is forced to travel "around" the isolated analog planes.

The need to have separate grounds in a printed circuit board or in a system is usually discussed and decided upon before the design begins. Often, when noise and other problems are perceived to be a possible problem, the designer will use separate analog and digital grounds in an effort to be conservative. Sometimes he's right and sometimes the grounds are separated needlessly.

The worst possible outcome is to design and build a printed circuit board with a common ground and then find that there is a substantial amount of digital noise getting into the analog circuitry. Then the entire board design must be redone. Sometimes separate grounds are needed and sometimes they're not.

Star ground or metal case or ground plane approach for analogue signal systems ?

Star grounding and using equipment metal chassis as a common have both their benefits and disadvantages when implementing them in equipments. Audio amplifiers are fairly sensitive to grounding schemes in terms of hum, noise, and rf pickup. Star grounding inside is the best method for fighting against hum and other noise problems, except RF noise. For preventing RF noise entering your system, it would be best to use metal case for your equipment and connect the connector and wiring shields (ground connector) directly to the case in the point where the connector enters the case.

Star grounding as it is a very good method for wiring analogue equipments. But when considering high frequency RF circuits, it is absolutely the wrong way to go, because at radio frequencies wire is no longer just a wire, it is effectively an inductor, which causes that the star grounding scheme which works very well for low frequencies does not work on RF.

The method of having RCA jacks insulated from the chassis and run the RCA grounds to the star ground is not recommended practice nowadays. Ground them to the chassis, this will maintain a continuous ground and supply the best immunity to RF interference. For the circuit design start with a continuous ground plane.

Unfortunately this ground plane solution is a good solution if only a relatively small dynamic range (20 dB for digital, 60 dB for video) is required. This means that ground plane approach is usable for many video circuits, digital circuits and not very demanding audio applications. However, high quality audio systems should be designed with 100 .. 120 dB dynamic range, thus with 1 V signal levels, any unwanted signals should be below 1 .. 10 μ V. With various AC and DC currents flowing in the circuit, sooner or later they are going to end up into the ground plane. So there is a risk of several microvolt (AC) potential differences across the ground plane. If the circuit topology is bad, this AC voltage (e.g. hum) is directly added to the signal. In a preamp, you also have to consider any leakage current flowing from the signal source, through the preamp ground to the power amp. Grounding topology does have very much effect how this current affects circuit operation.

One good idea for building a very high quality audio equipment is to keep the traditional star grounding topology inside the equipment and prevent any RF from entering the enclosure. By keeping the RF out of the main circuit board, the LF grounding can be more freely done, according to audio requirements.

To keep the RF out, the equipment enclosure should be fully metallic and any removable panels should be tightened with screws (every 5 .. 10 cm so that they make good contact). For both input and output use connectors isolated from the enclosure, but connect the connector ground terminal through a capacitor (1 .. 10 nF) with as short wire as possible. The capacitor will have a low impedance at RF, but 100 k .. 1 Mohm impedance at hum frequencies and their harmonics, thus adding very little hum. This approach is recommended for all unbalanced connectors (RCA, 6.3 mm jack, 3.5 mm jack, BNC etc.). If you are using balanced connections with XLR connectors, wire the pin 1 ground directly to the case (do not connect it to the analogue signal star ground points).

For extra protection add ferrite beads to the wires inside equipment. Ferrite beads with a few turns of wire mounted close to the socket into both the signal and ground terminals of the connector will have an RF impedance of several hundred ohms but still practically no effect at audio frequencies. For adding effectively of this on input circuits, add a small 100pF-1nF chip capacitor after the ferrite beads from the signal wire to the ground (with 1000 ohm signal source impedance, this capacitor could be up to 1 nF, thus the corner frequency of 160 kHz). Do not use this kind of capacitor on the output circuits, since this can cause stability problems to some op-amps.

[Tomi Engdahl](mailto:Tomi.Engdahl@iki.fi) <Tomi.Engdahl@iki.fi>

Published by ELH Communications Ltd. all rights reserved.

Other noise and hum sources than groundloops

There are also other sources of noise which can cause humming to audio systems than groundloops. If you have done all the countermeasures against groundloops and still have the problems or your problems seems not be caused by groundloops look at the possibility of other sources of noise as described in this document.

RFI issues

Audio cables can act as effective antennas for RF energy. Preamplifiers and other audio input devices vary widely in their tolerance of RF signals. In audio system where there has been done lots to avoid ground loop problems, cable shields "float" at one end. The downside is that this makes each cable act as an effective whip antenna. If the cable length and ambient RF frequencies are just right (Murphy's law will attend to this), the whip antenna becomes tuned and can produce very high RF voltages at its floating or ungrounded end (and that RF will then capacitively couple to audio signal wires inside the cable shield).

This RF voltage can be reduced by terminating the floating end of the cable at RF frequencies through a series network which consists of series connected 51 ohm resistor and 10 nF ceramic capacitor. This network terminates the line at frequencies above 300 kHz, but looks "open" at audio frequencies (so avoids forming "ground loop").

EMI issues

Hum and noise can also enter the audio signal path magnetically. Basic physics tells that any conductor (wire) exposed to varying magnetic field will have an AC voltage "induced" to it. To avoid magnetically picked noise in the cable it is a good idea to keep the audio cables at some distance away from devices like high current carrying cables, light dimming systems, transformers (any equipment which has big transformers) and large electrical motors. All of those can be a serious source of electromagnetic noise which can enter to audio cable and cause humming noise.

Unbalanced audio connections will pick magnetically coupled noise easily. The normal cable shield which is very effective in shielding against capacitively coupled noise has almost no effect on magnetically coupled noise. Only effective ways to fight against magnetic noise in unbalanced connections are keeping the cables away from magnetic noise sources (magnetic fields drop very rapidly with the distance from the source, so even few centimeters movement of cable can help to reduce the problem) or placing lot of iron (or other magnetic material) between the noise source and the cable (like putting the audio cable inside an iron tube).

The only cable mechanical construction which can avoid magnetic noise pickup in audio cable effectively is making cable such that two signal conductors have exactly the same distance to the magnetic source. Tightly twisting of balanced signal conductors help to make average distance of each conductor to any outside magnetic field source the same. Combination twisted pair shielded cable and balanced connection is very effective way to fight against magnetic noise. A cable type called "star quad" improves magnetic noise resistance of the cable by effectively averaging the magnetic pickup of four conductors (the downside of this cable is higher price, harder connection to connectors and higher cable capacitance than normal shielded twisted pair cables).

Even when you are using twisted pair cables all parts of your system are not completely shielded against magnetically picked noise. Every part of the signal chain where the cable conductors are not twisted can still pick up magnetic interference. A mated pair of XLR connectors leaves many centimeters (3-5 centimeters) of signal conductors untwisted and is very vulnerable to magnetic pickup. It would be bad idea to lay pair of such connectors near any strong magnetic field (like on top of power amplifier or audio equipment mains power supply).

Wires are not the only components in audio system which can pick up magnetic fields. Any audio transformer can also pick up magnetic noise (good ones less, poorer ones more). If your audio system used audio isolation transformers for audio signal isolation it is a very good idea to keep those away from magnetic noise sources.

