

SERVICE MANUAL & PARTS LIST

EV-510B

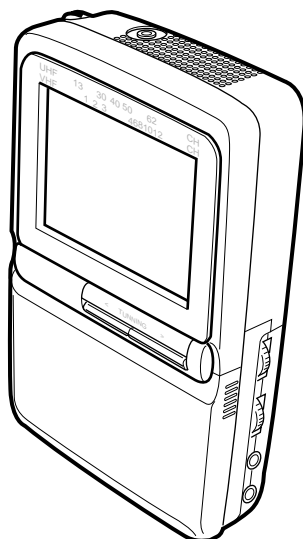

CASIO

CASIO

PRINTED CIRCUIT BOARDS

TOP VIEWS
Linear

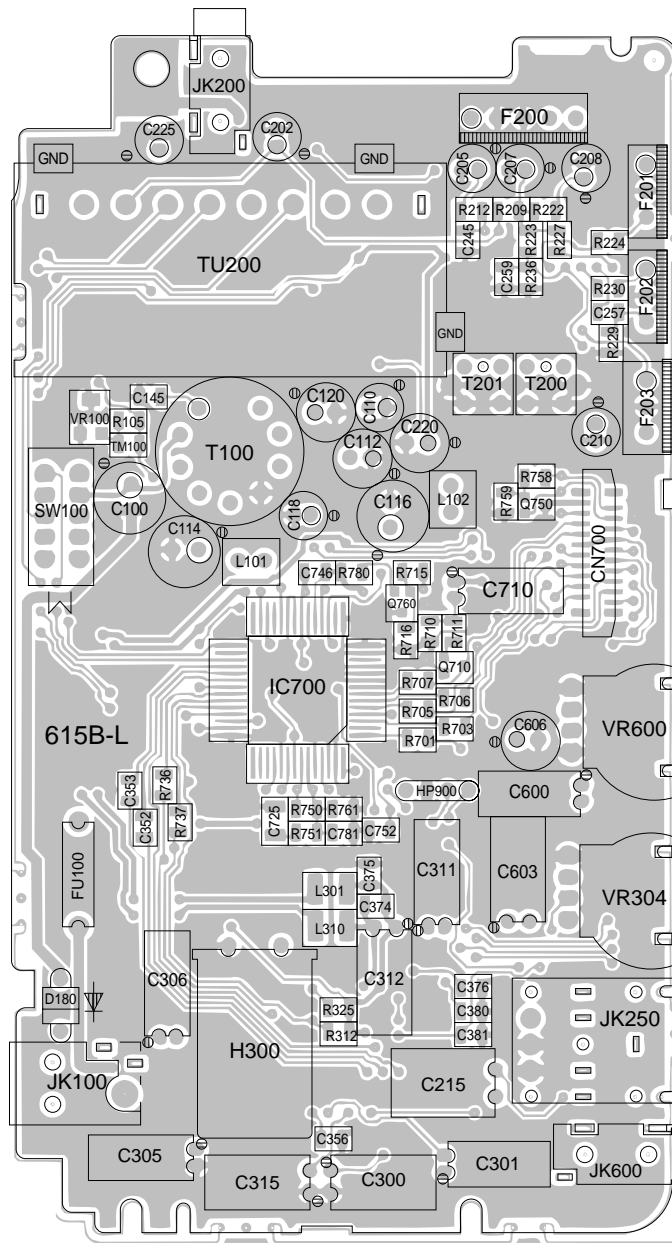

BL

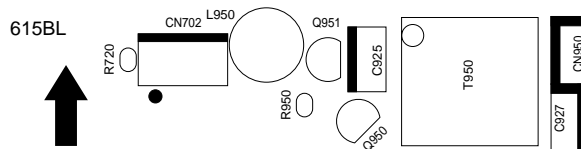

BOTTOM VIEWS

Linear

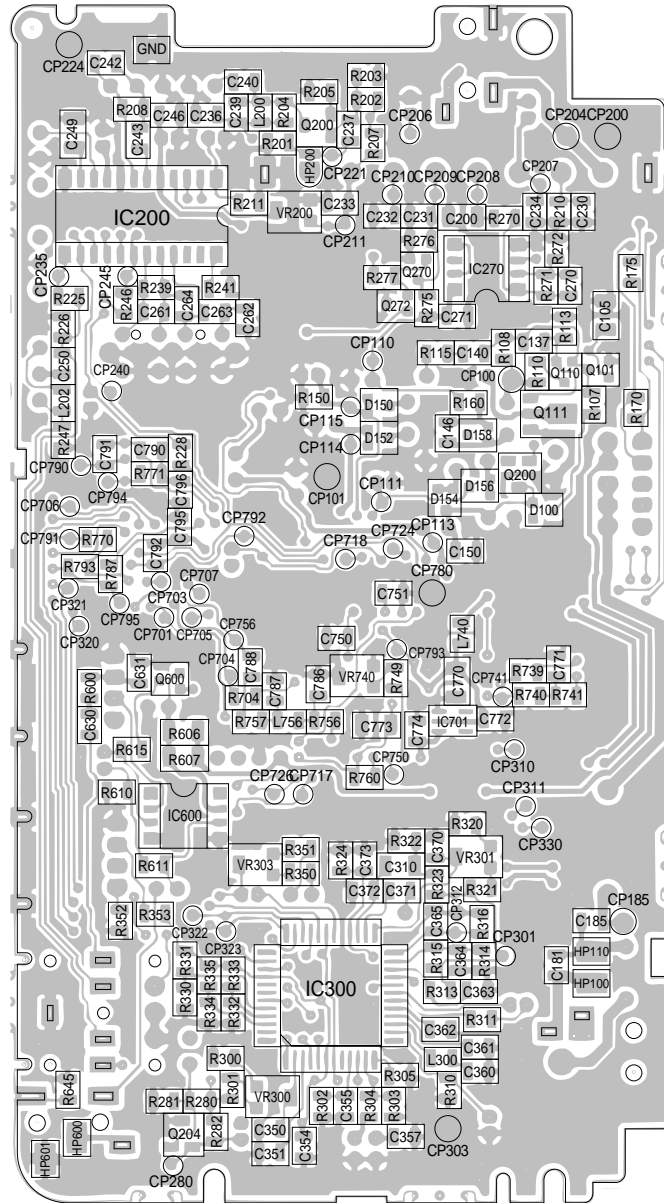

BL

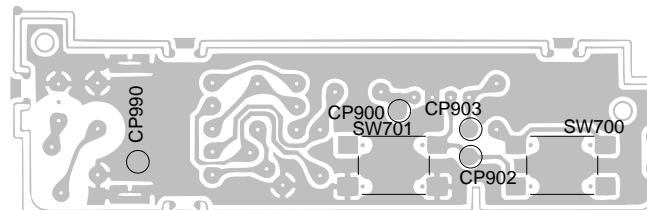

EXPLODED VIEW

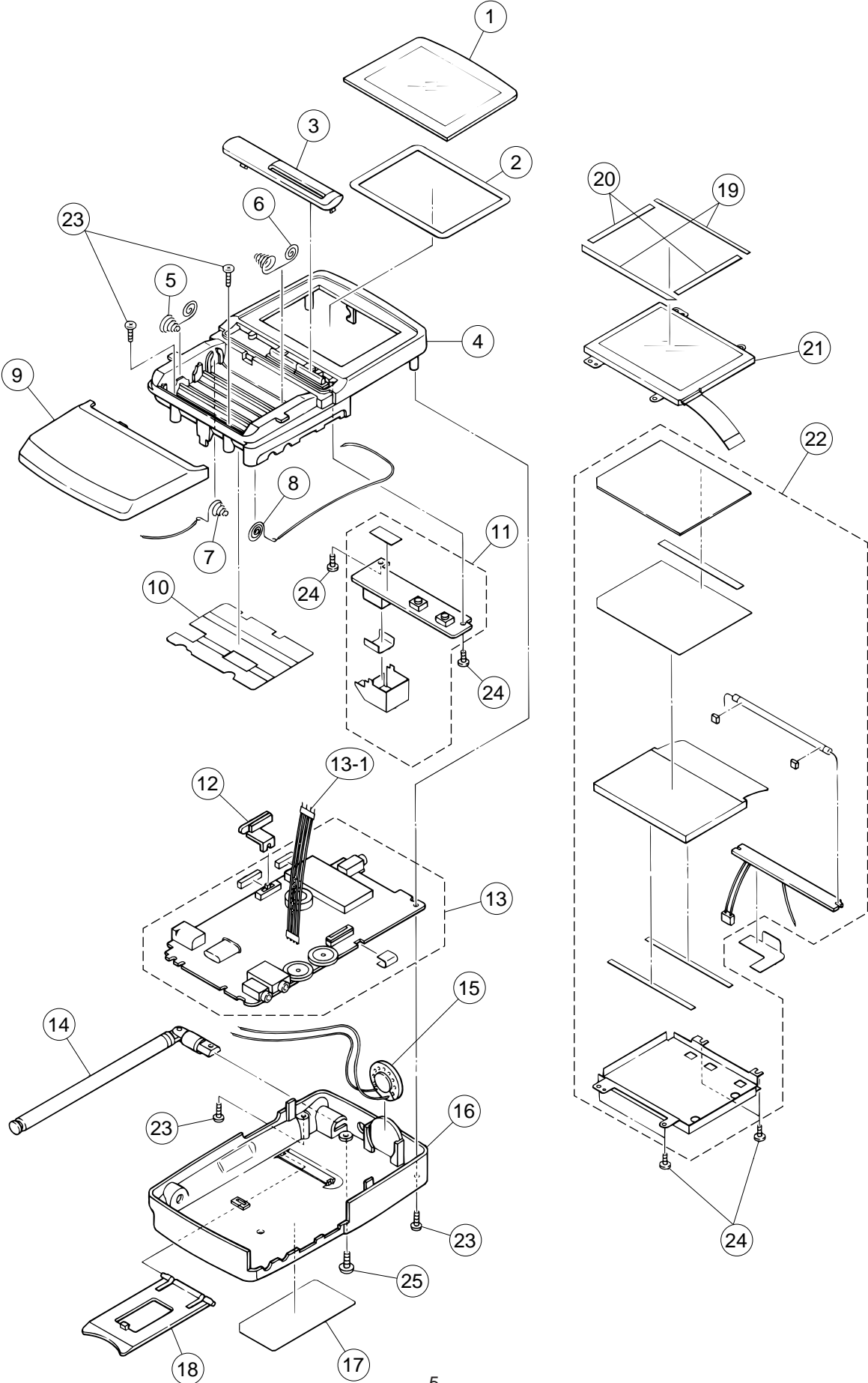

SCHEMATIC DIAGRAMS

LINEAR

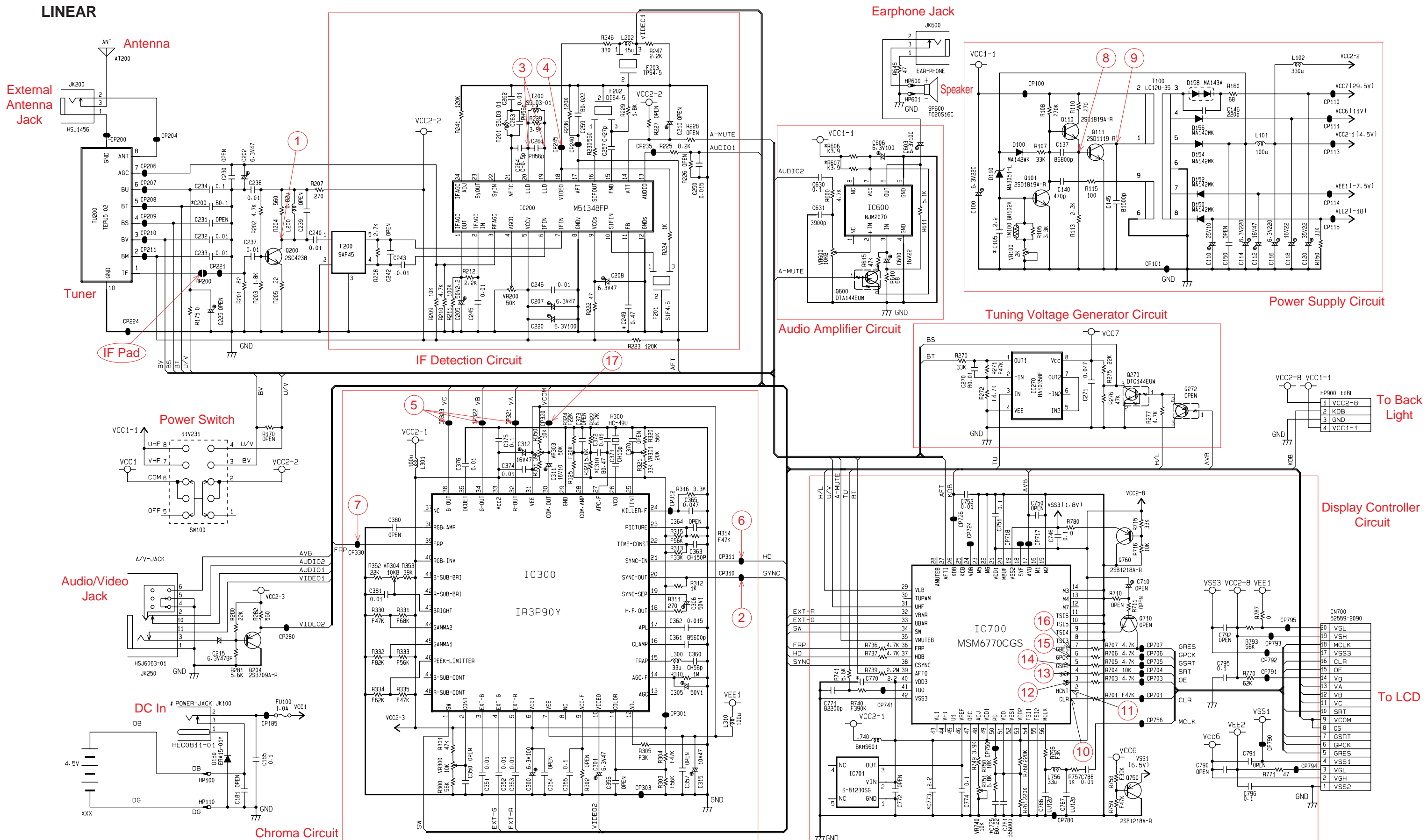

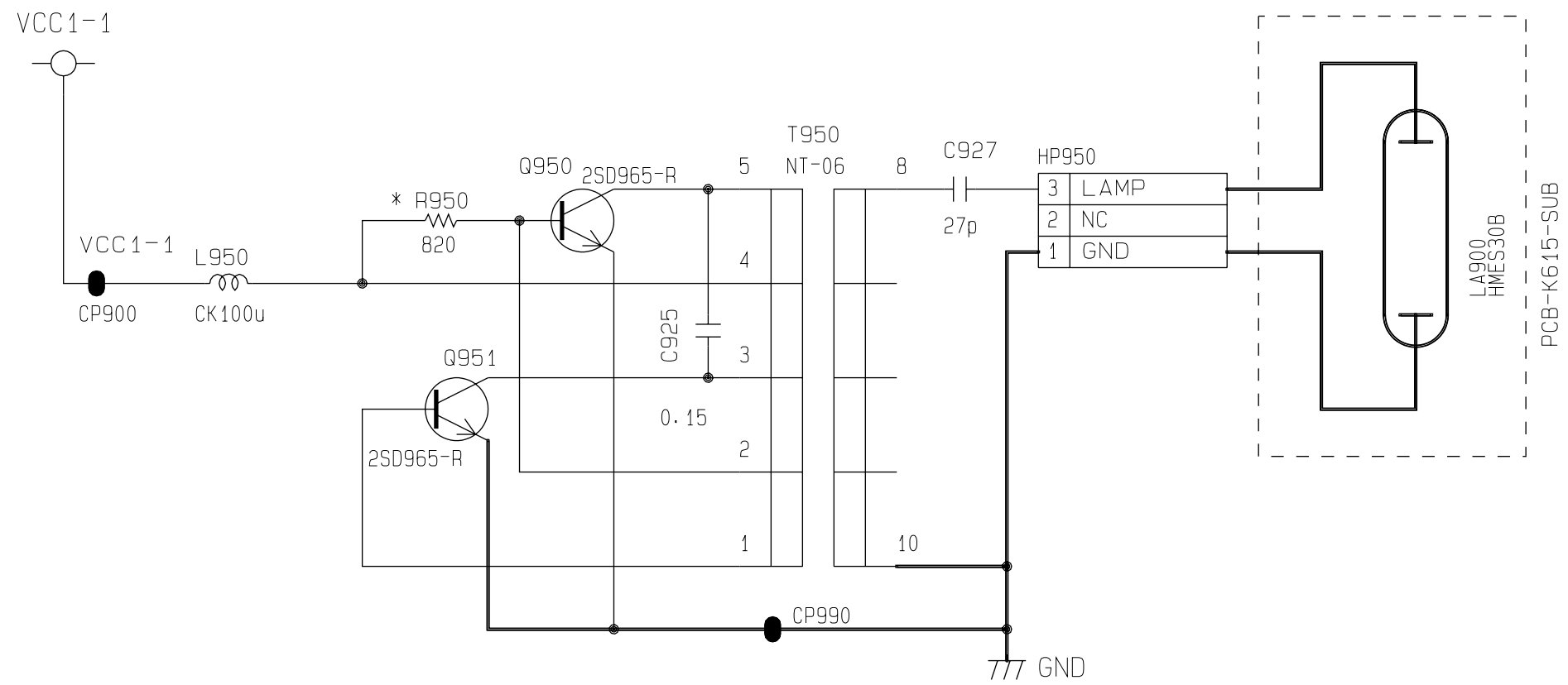
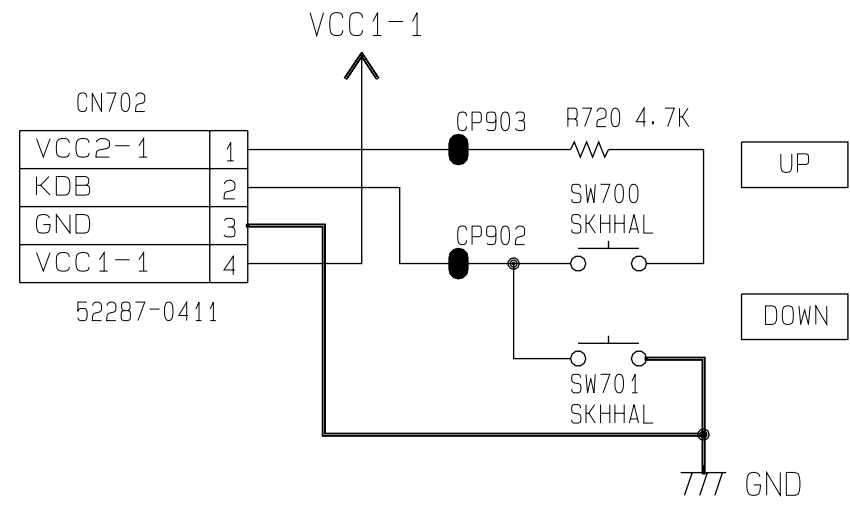

WAVEFORMS

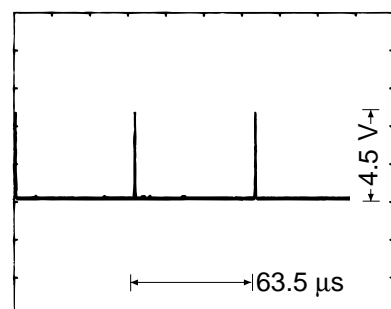
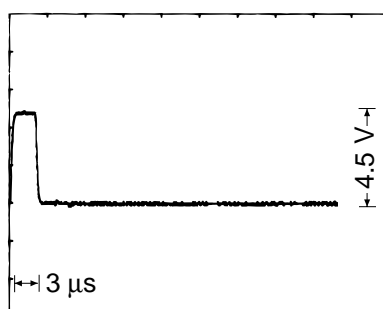
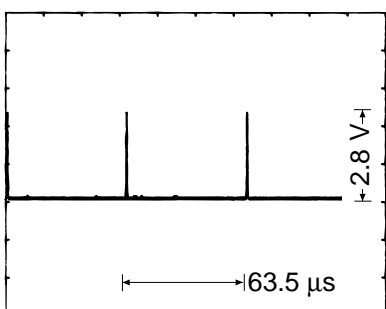
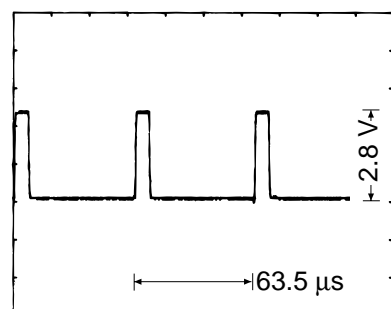
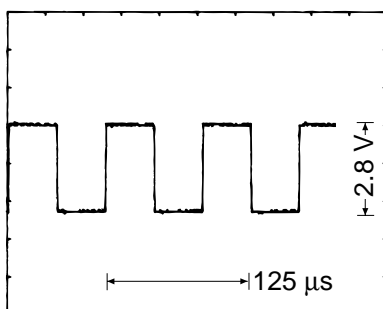
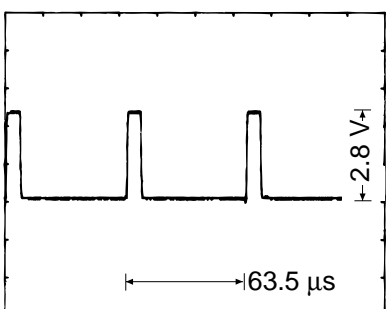
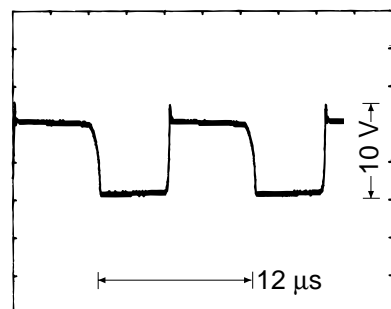
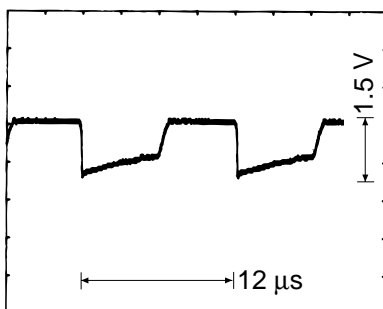
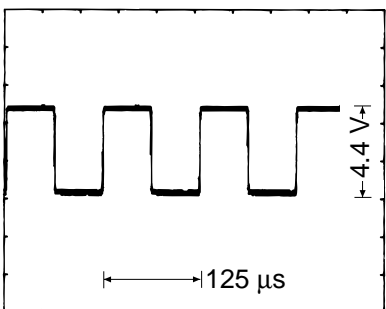
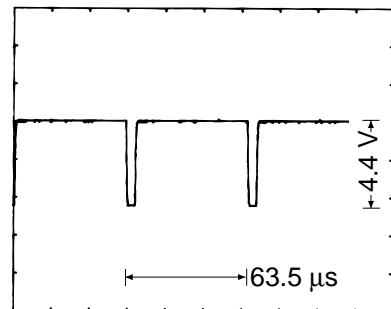
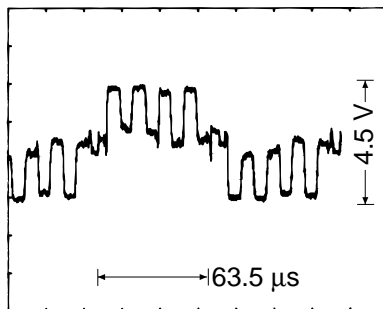
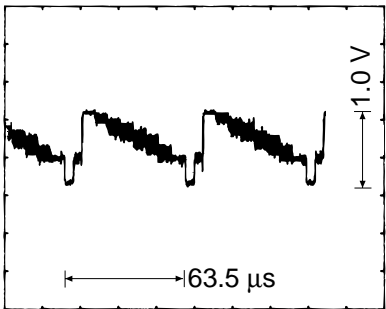
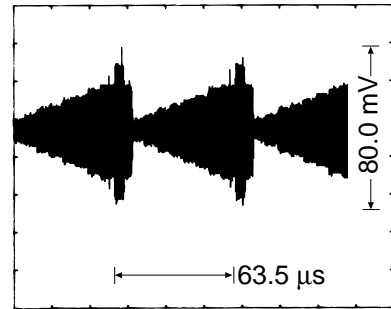
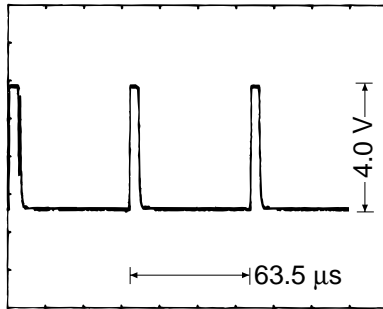
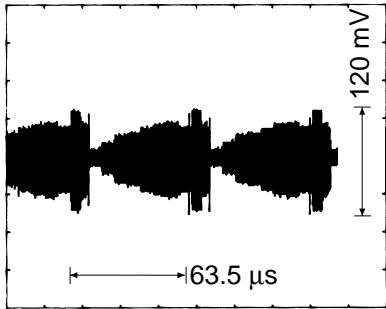

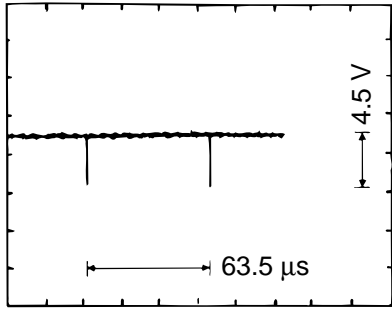

⑩ IC700 pin 7

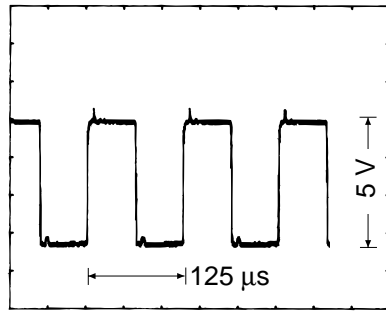

⑪ IC300 pin 30