

# Function Block of V30 107T5

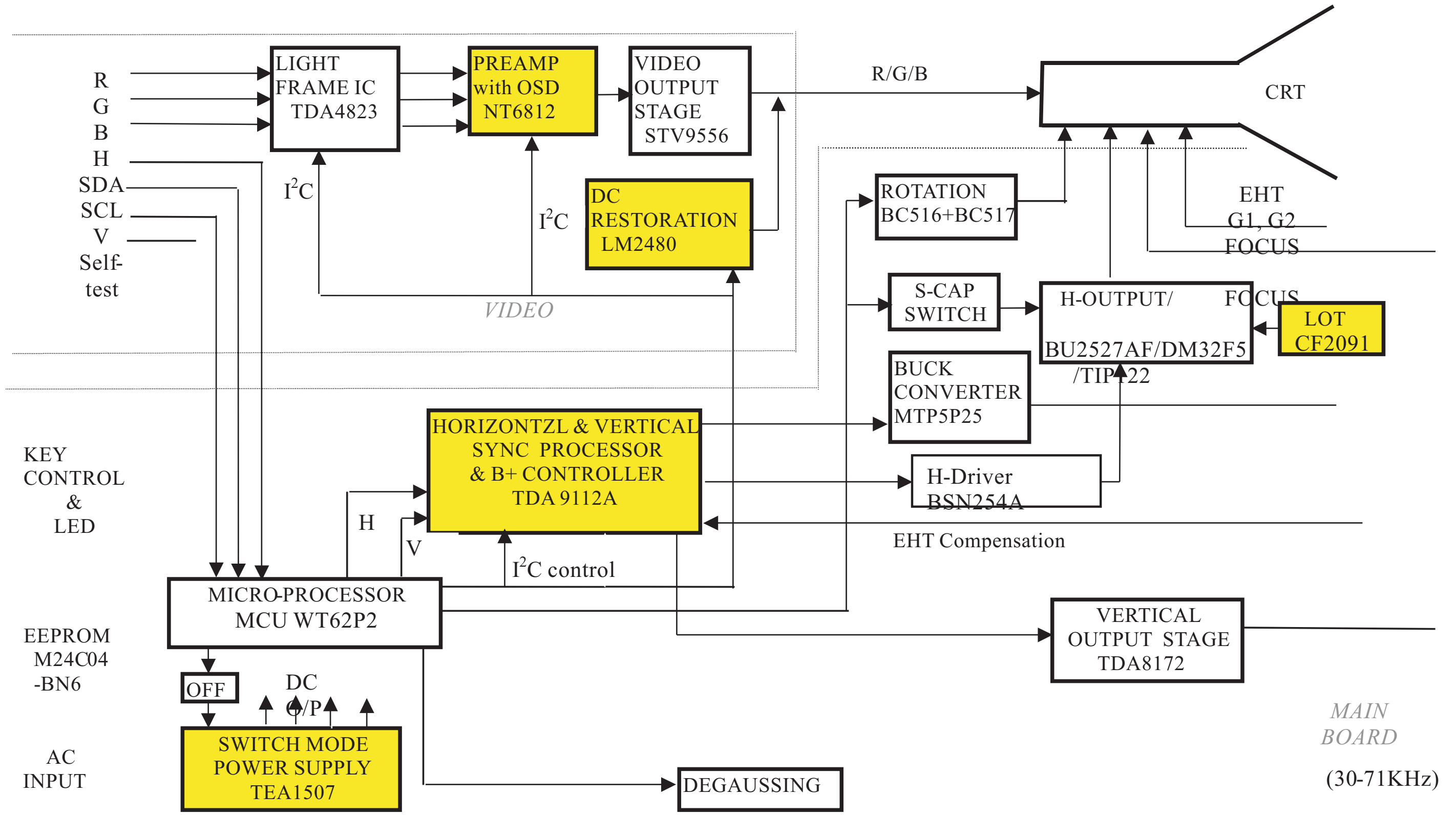

Go to cover page

# Schematic Diagram of Main board

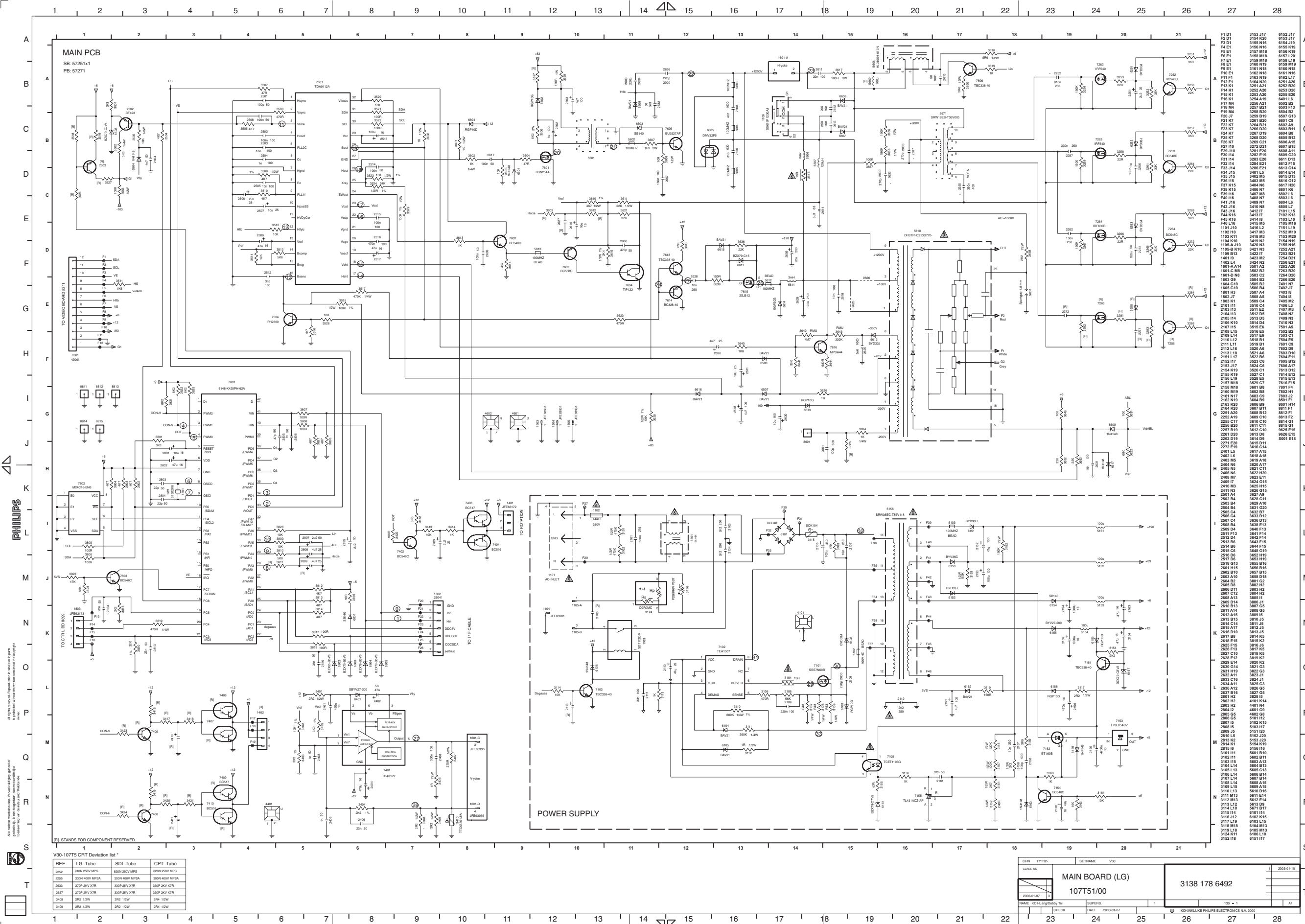

PHILIPS  
 All rights reserved. Reproduction or modification of this document is prohibited without the written permission of Philips.  
 Philips reserves the right to change specifications without notice.

V30-107T5 CRT Deviation list \*

REF.	LG Tube	SDI Tube	CPT Tube
2252	339N 200V MPTA	339N 200V MPTA	339N 200V MPTA
2253	339N 400V MPTA	339N 400V MPTA	339N 400V MPTA
3033	270P 20V XTR	330P 20V XTR	330P 20V XTR
3037	270P 20V XTR	330P 20V XTR	330P 20V XTR
3408	2R2 1.0W	2R2 1.0W	2R2 1.0W
3409	2R2 1.0W	2R2 1.0W	2R2 1.0W

CHK	TYTD	SETNAME	V30
CLASS NO	MAIN BOARD (LG)		300301-10
DATE	107T5/00		3138 178 6492
NAME	NO	DATE	2003-01-07
CHECK	DATE	NO	1
ROKINLANS PHILIPS ELECTRONICS N.V. 2003			A1

0. 1802-2

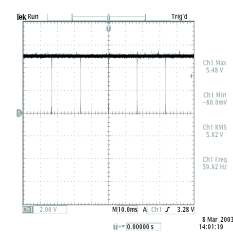

6. 7801-8

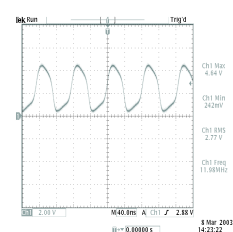

12. 7501-12

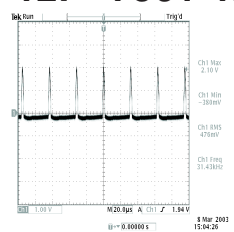

18. 7501-26

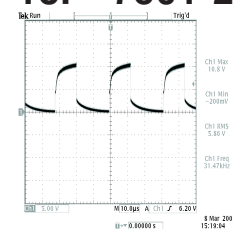

24. 7613-B

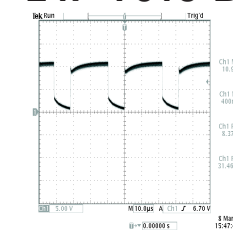

30. 7101-D

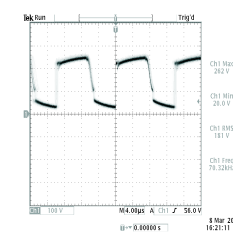

1. 1802-3

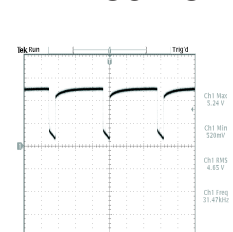

7. 7801-7

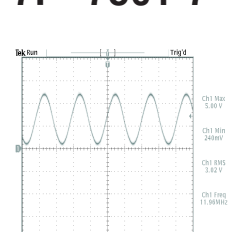

13. 7501-13

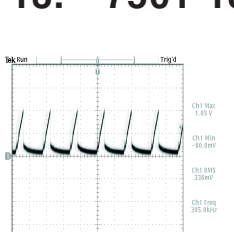

19. 7501-29

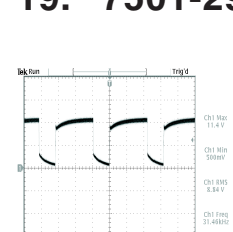

25. 7613-E

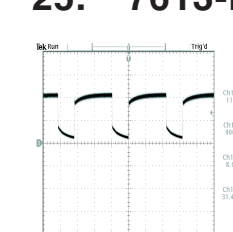

31. 7102-8

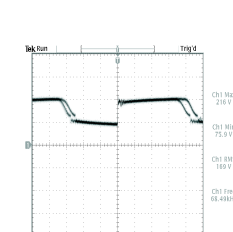

2. 7801-33

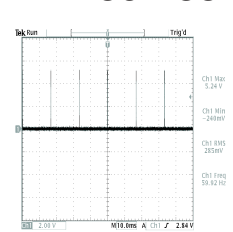

8. 7801-28

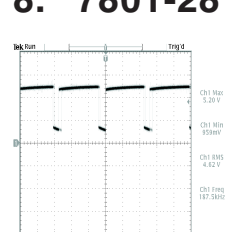

14. 7501-14

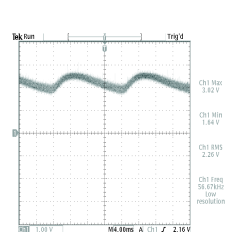

20. 7601-D

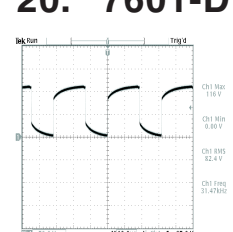

26. 7615-D

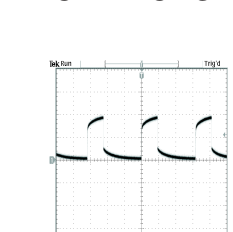

32. 5156-14

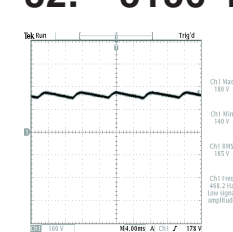

3. 7801-34

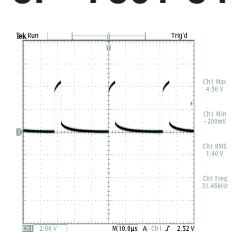

9. 7801-29

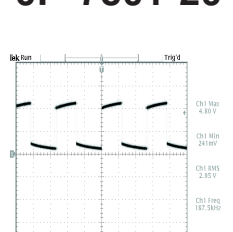

15. 7501-15

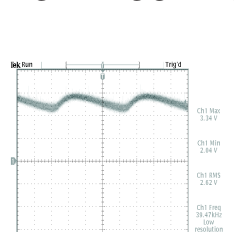

21. 5601-2

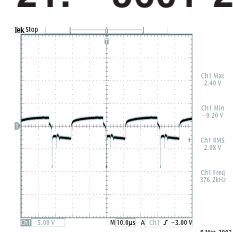

27. 7401-5

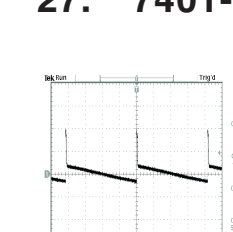

33. 5156-10

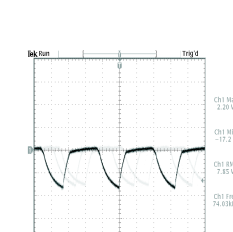

4. 7801-3

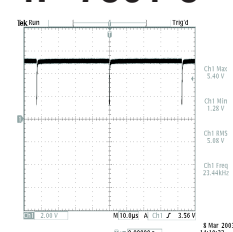

10. 7801-30

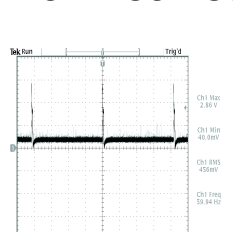

16. 7501-22

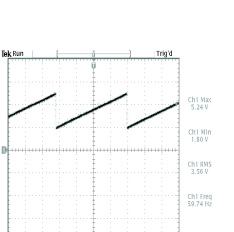

22. 7605-C

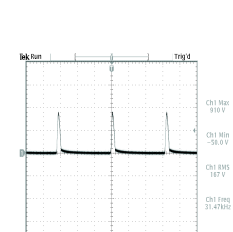

28. 1601-D

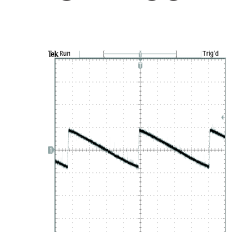

5. 7801-4

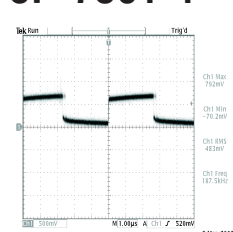

11. 7501-3

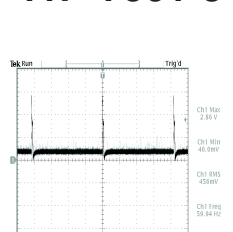

17. 7501-23

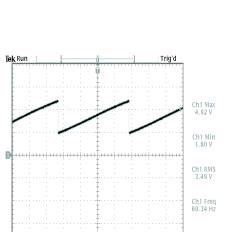

23. 1601-A-2

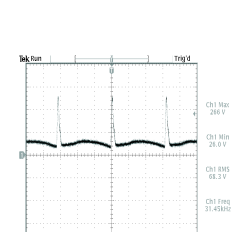

29. 7101-S

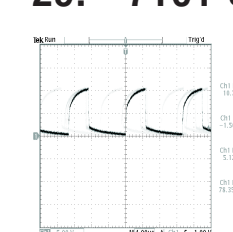

# Schematic Diagram of Video board

Go to cover page

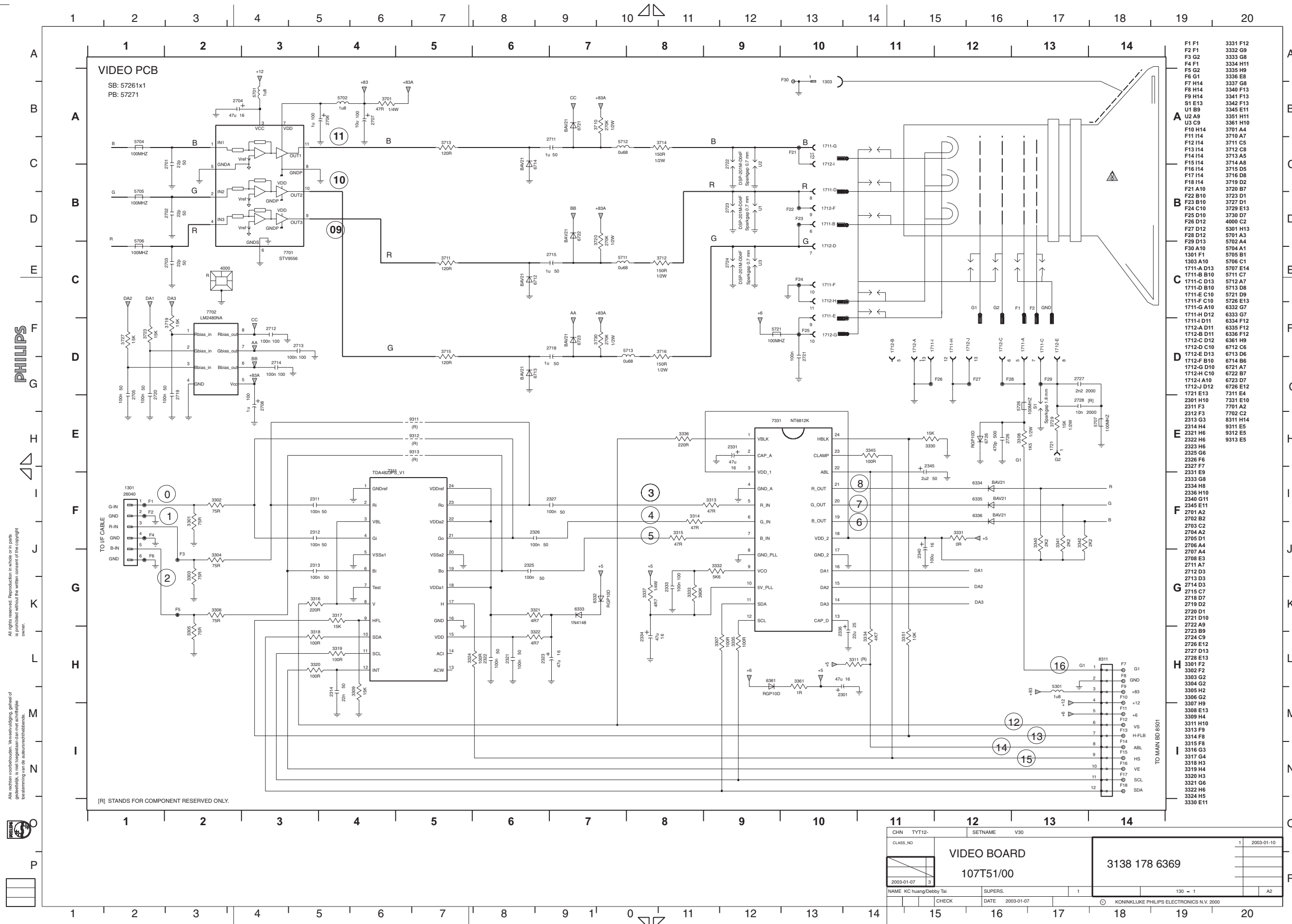

PHILIPS

All rights reserved. Reproduction in whole or in part is prohibited without the written consent of the copyright owner.

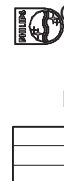

CHN	TYT12-	SETNAME	V30
CLASS_ID		VIDEO BOARD	
		107T51/00	
		3138 178 6369	
NAME	KC Huang/Debbay Tai	SUPERS.	1
CHECK		DATE	2003-01-07
			130 - 1
			KONINKLIJKE PHILIPS ELECTRONICS N.V. 2000

0. 1301-1

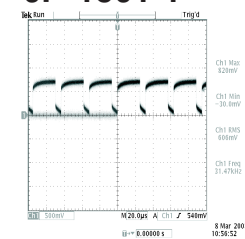

4. 7331-6

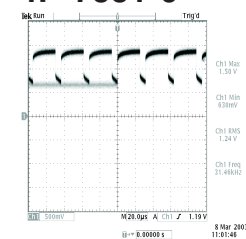

8. 7331-8

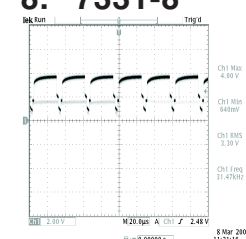

12. 8311-6

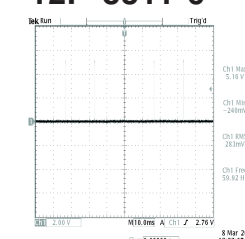

16. 8311-1

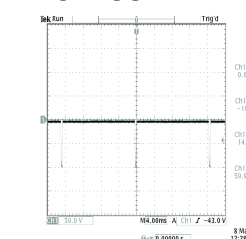

1. 1301-2

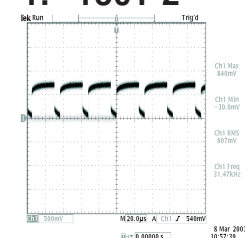

5. 7331-7

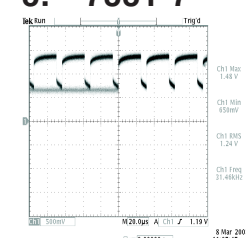

9. 7701-9

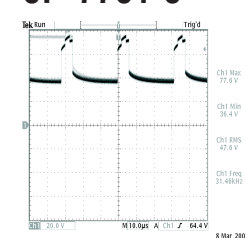

13. 8311-7

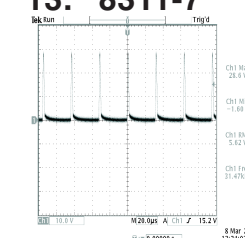

2. 1301-5

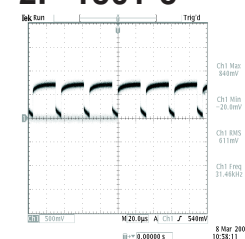

6. 7331-19

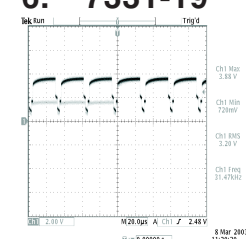

10. 7701-10

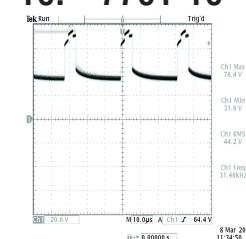

14. 8311-8

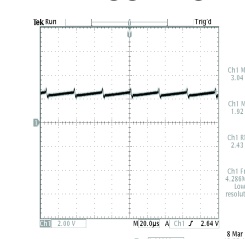

3. 7331-5

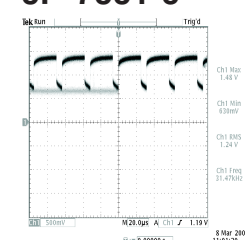

7. 7331-20

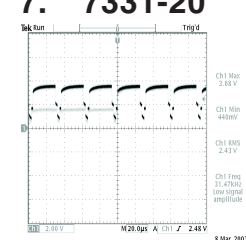

11. 7701-11

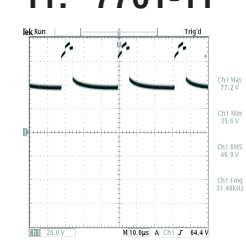

15. 8311-9

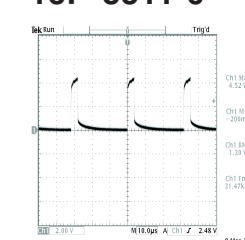

**PHILIPS**

All rights reserved. Reproduction in whole or in parts is prohibited without the written consent of the copyright owner.

Alle rechten voorbehouden. Vervolmaking, geheel of gedeeltelijk, is niet toegestaan dan met schriftelijke toestemming van de auteursrechtbehebende.

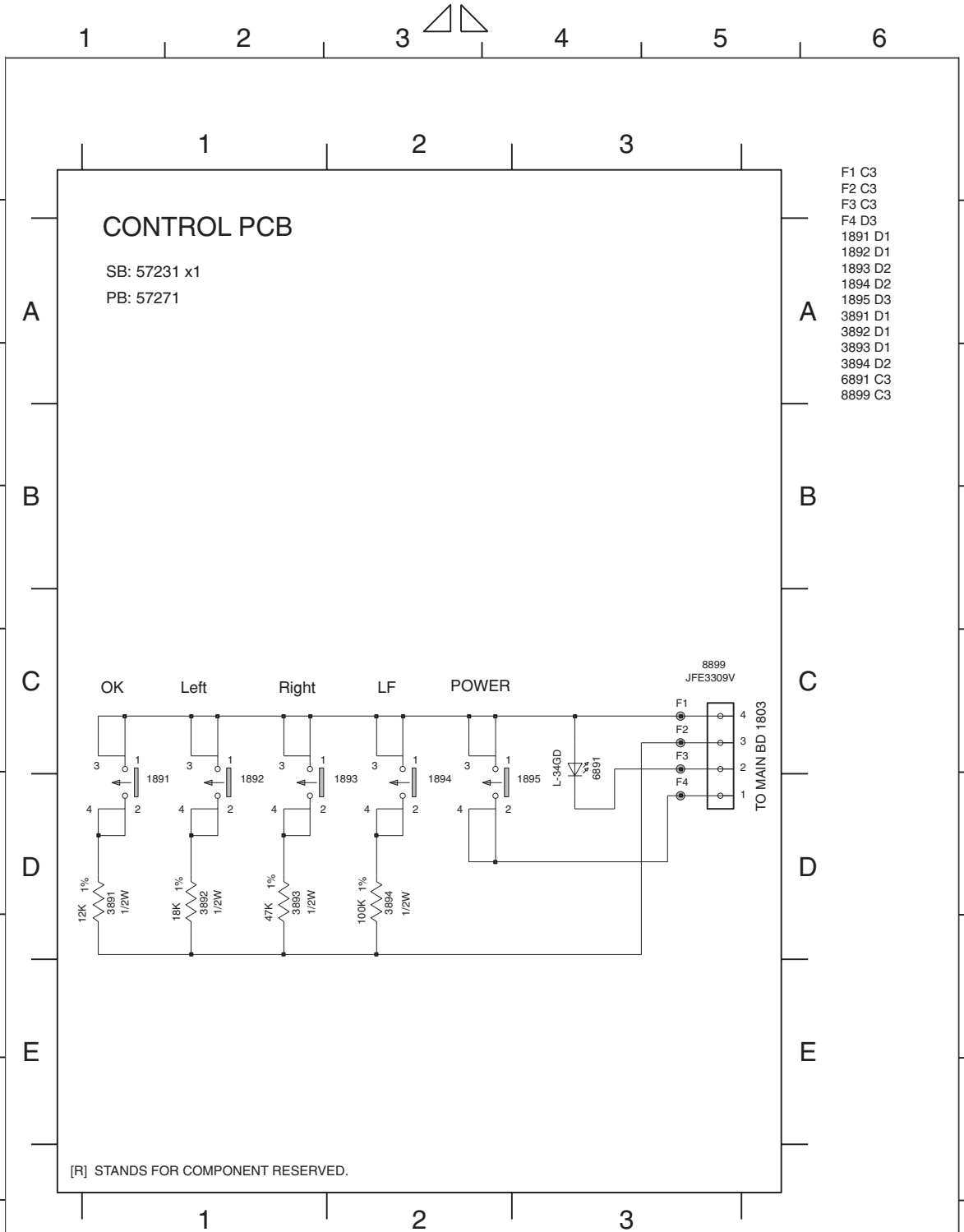

[R] STANDS FOR COMPONENT RESERVED.

CHN	TYT12-	SETNAME	V30
CLASS_NO	CONTROL BOARD		1 2003-01-03
	107T51/00		3138 178 6374
NAME	Roland/Ivy Su	SUPERS.	1 130 - 1 A4
CHECK	DATE	2003-01-03	© KONINKLIJKE PHILIPS ELECTRONICS N.V. 2000