

SERVICE DATA
FILE NO. 050-153
8-SYSTEM

TOSHIBA

COLOUR TELEVISION

215R8W

センターファイル
Center File

RTV servis Horvat

Kešinci, 31402 Semeljci

031-856-139

031-856-637

098-788-319

rtv-servis-horvat@os.tel.hr

Croatia

SPECIFICATIONS

Power Input Rating:	77 watts, AC 220 volts, 50 Hz
Aerial Input Impedance:	75 ohm unbalanced type for VHF and UHF
Receiving Channels:	CCIR (B/G-PAL standard, B/G-SECAM standard) VHF channels E2 to E12 and S1 to S20 UHF channels 21 to 69 CCIR (I-PAL) UHF channels 21 to 68 CCIR (D/K-PAL standard, D/K-SECAM standard) VHF channels 1 to 12 UHF channels 21 to 69 PAL, SECAM 50Hz/60Hz (For Video Disk playback) 4.43NTSC (For VCR playback)
Intermediate Frequencies:	Picture I-F carrier frequency 38.9 MHz Sound I-F carrier frequency B/G System 33.4 MHz I 32.9 MHz D/K 32.4 MHz
Picture Tube:	21 inches, A51EBV12X01, 510 mm (measured on diagonal of viewable picture area), 90° deflection.
Sound Output:	3.0 watts (at 10% harmonic distortion), Max. 3.5 watts
Speaker:	Round 100 mm
Aux Terminal:	Earphone Socket
Cabinet:	Table type
Dimension:	Height 465 mm Width 500 mm Depth 476 mm
Weight (Net):	24.1 kg

Specifications are subject to change without notice.

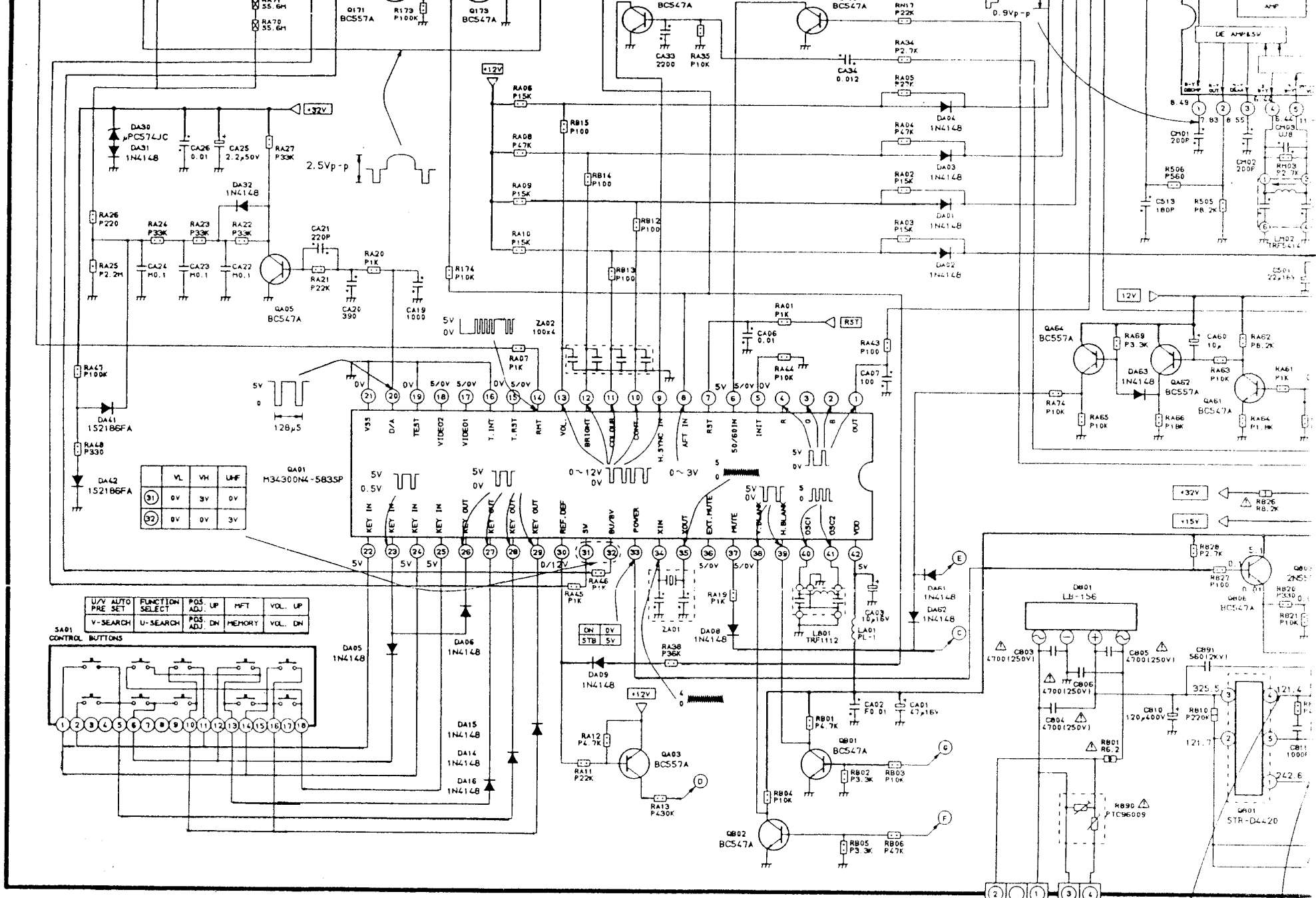

TOSHIBA

COLOUR TELEVISION

215R8W

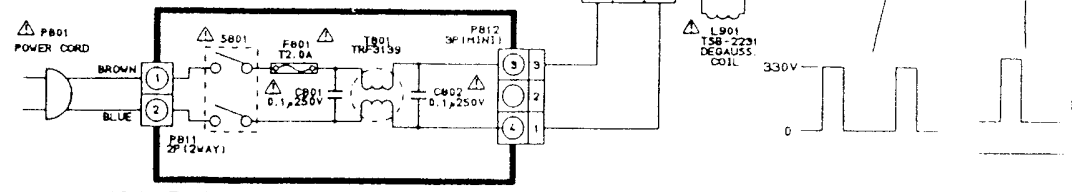

U901B POWER BOARD PW6674-2

U901A CRT DRIVE BOARD

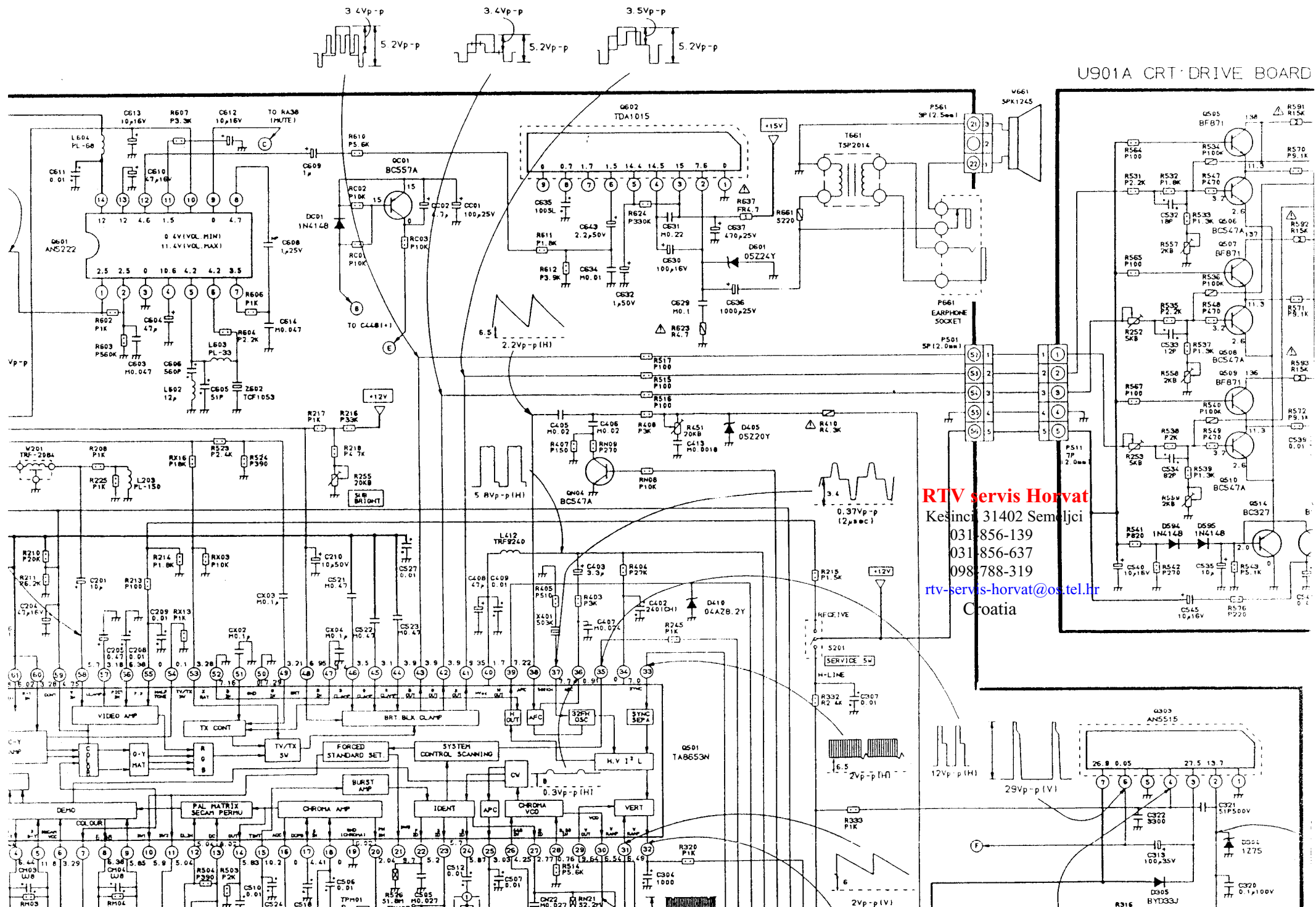

RTV servis Horvat
 Kešinci 31402 Semeljci
 031-856-139
 031-856-637
 098-788-319
rtv-servis-horvat@os.tel.hr
 Croatia

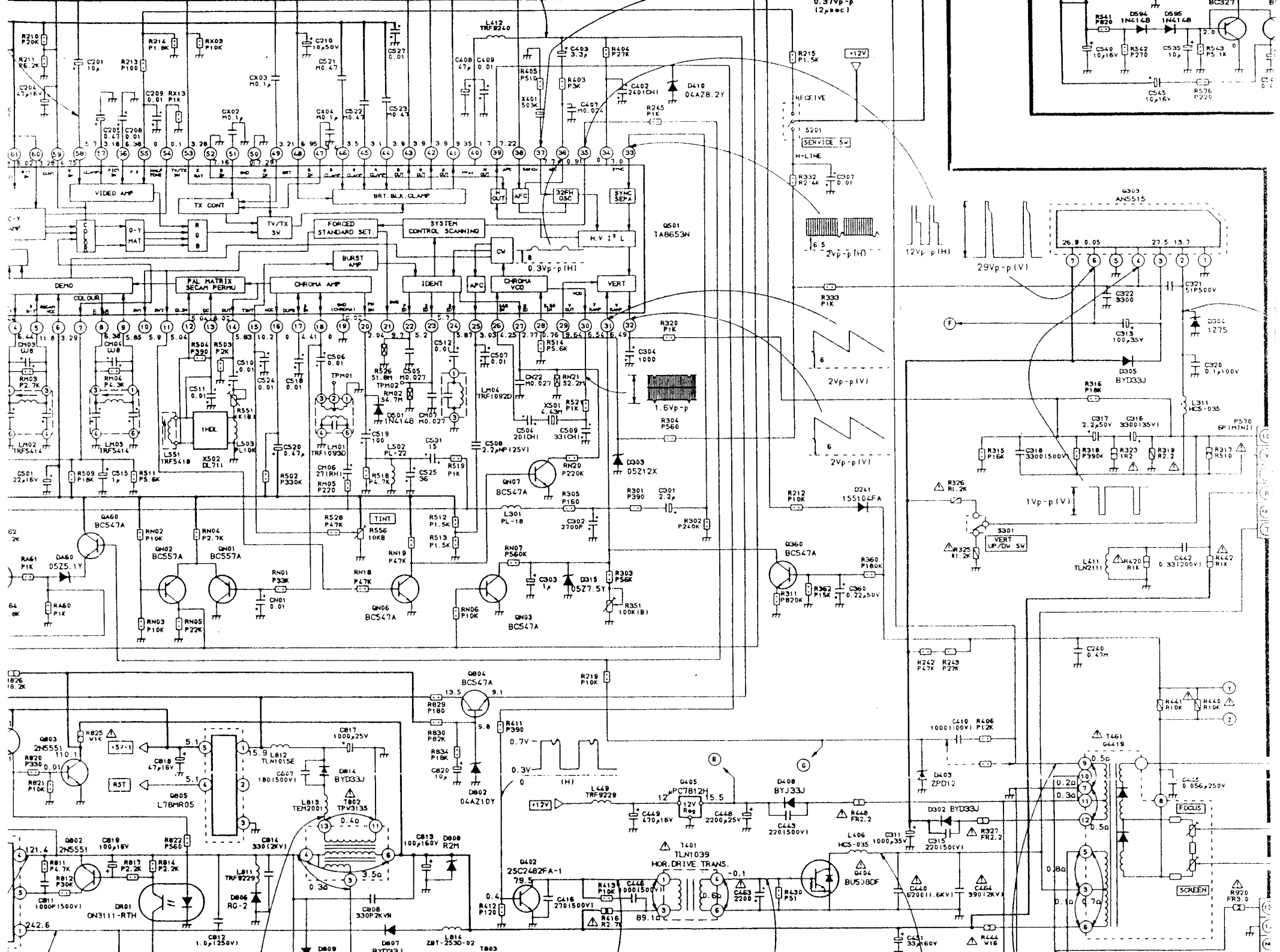

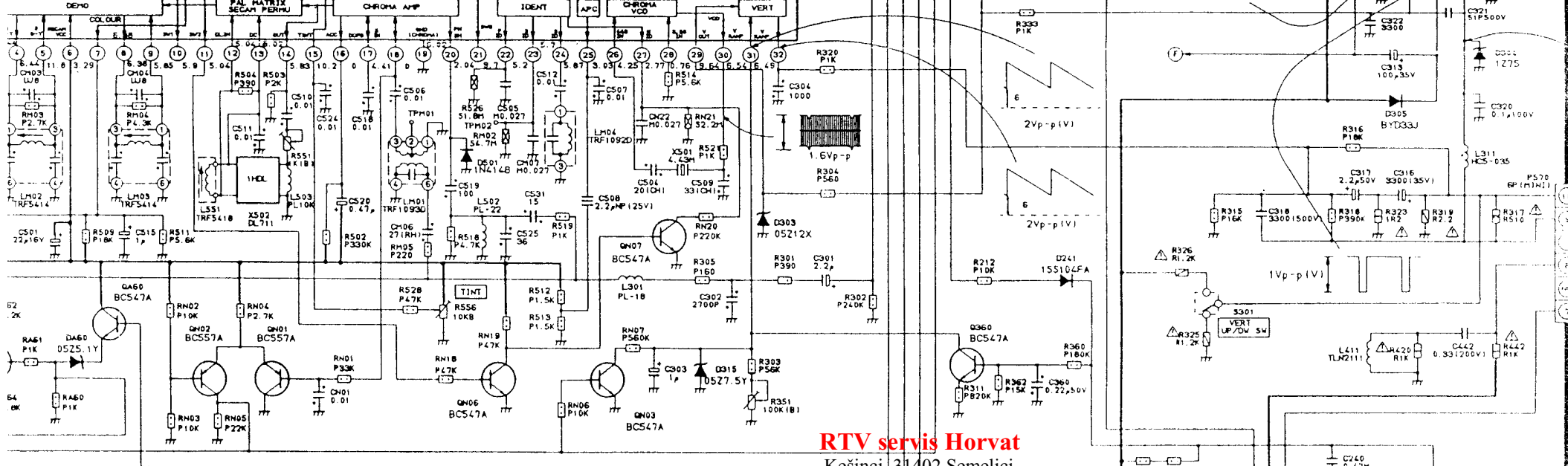

RTV servis Horvat
 Kešinci, 31402 Semeljci
 031-856-139
 031-856-637
 098-788-319
rtv-servis-horvat@os.tel.hr
 Croatia

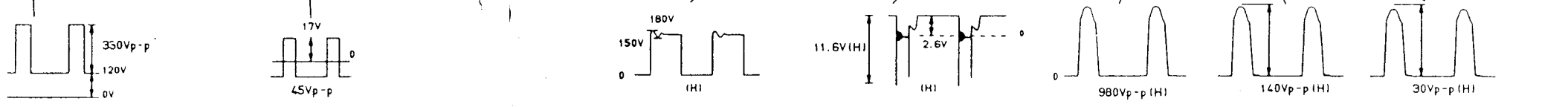
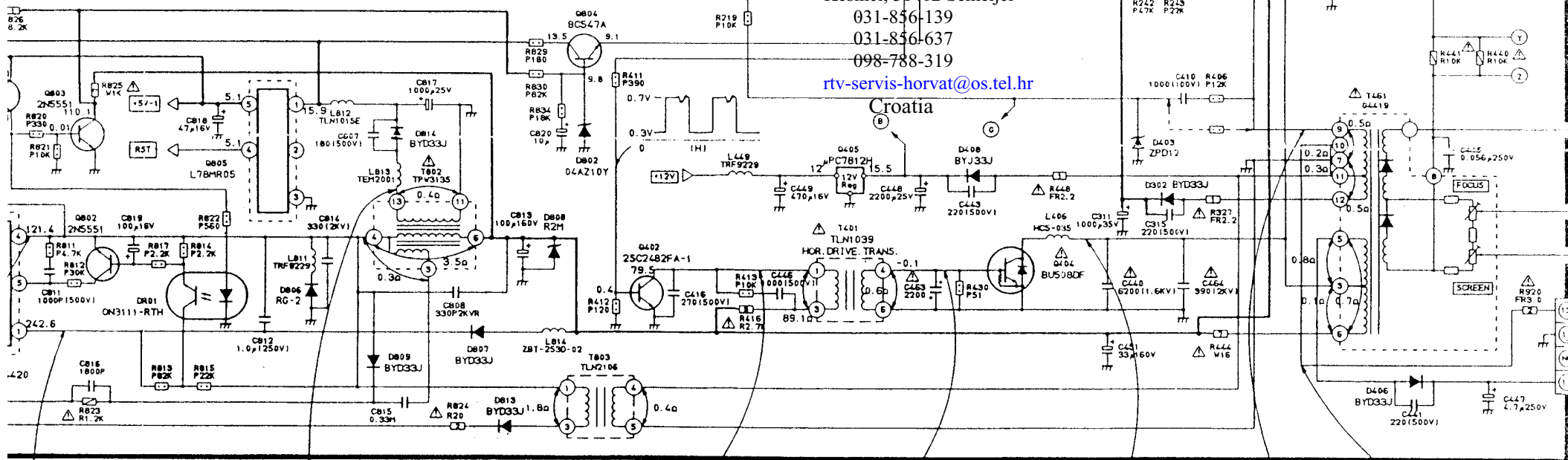

U901A CRT DRIVE BOARD PW6674-1

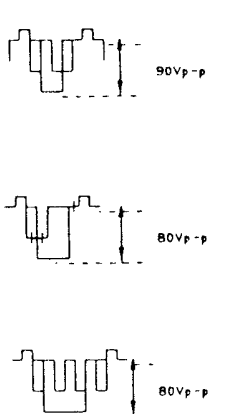
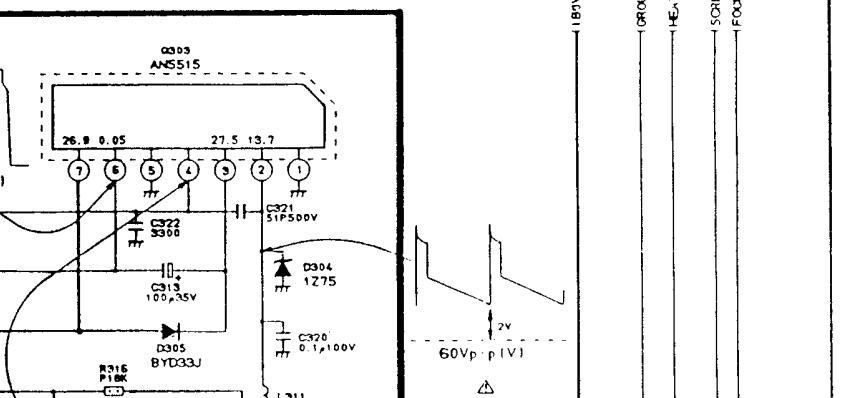
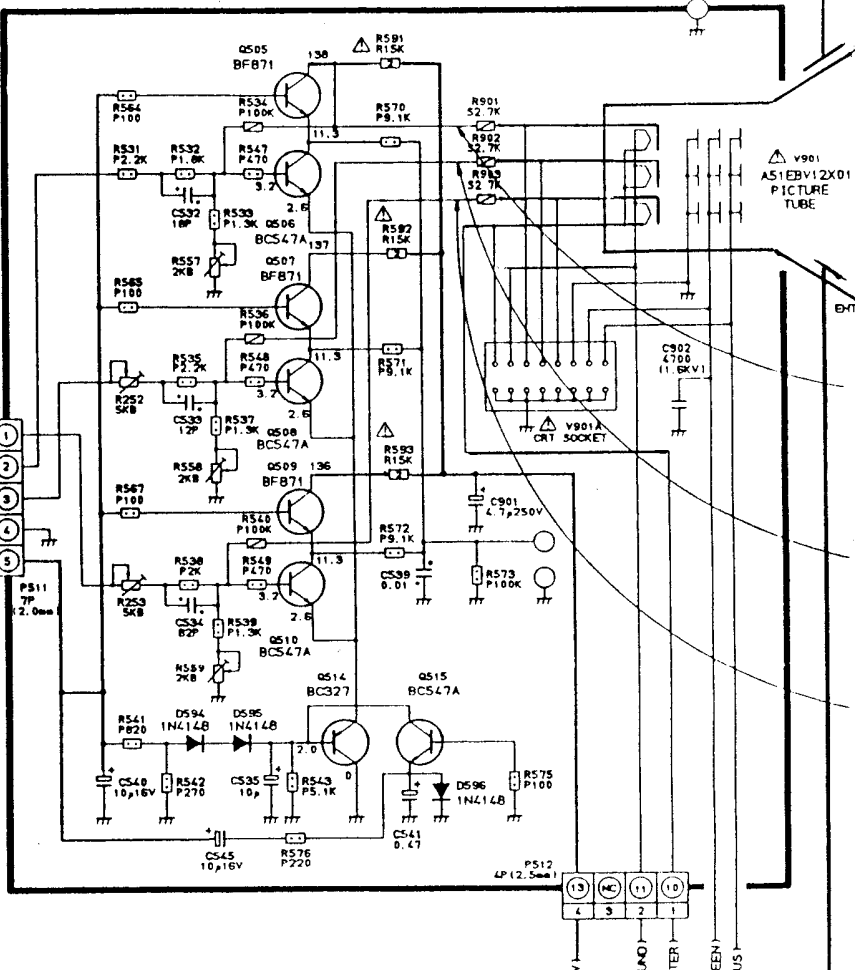
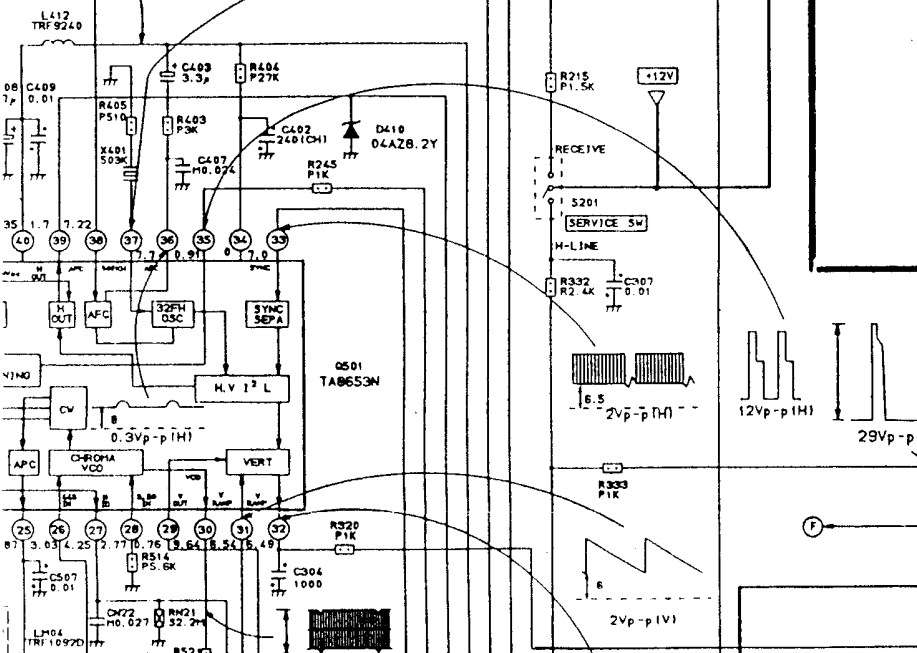
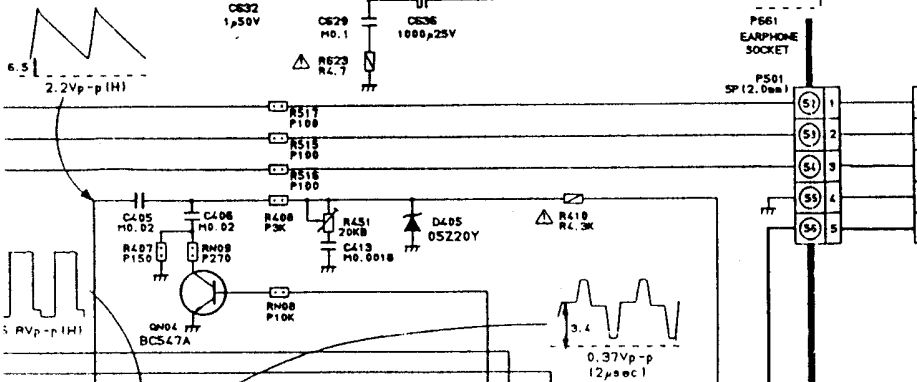
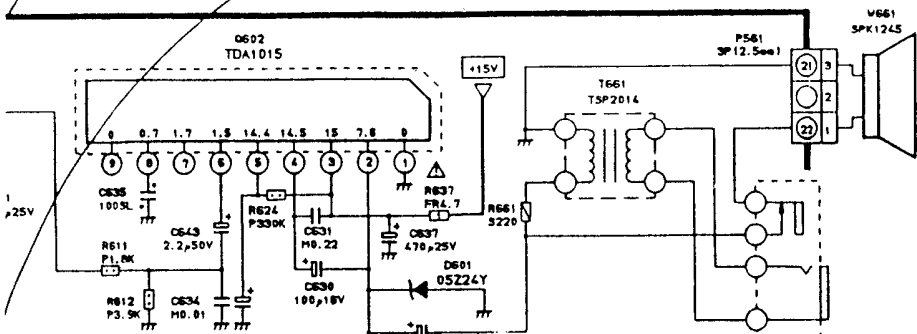
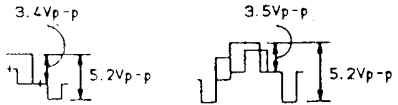

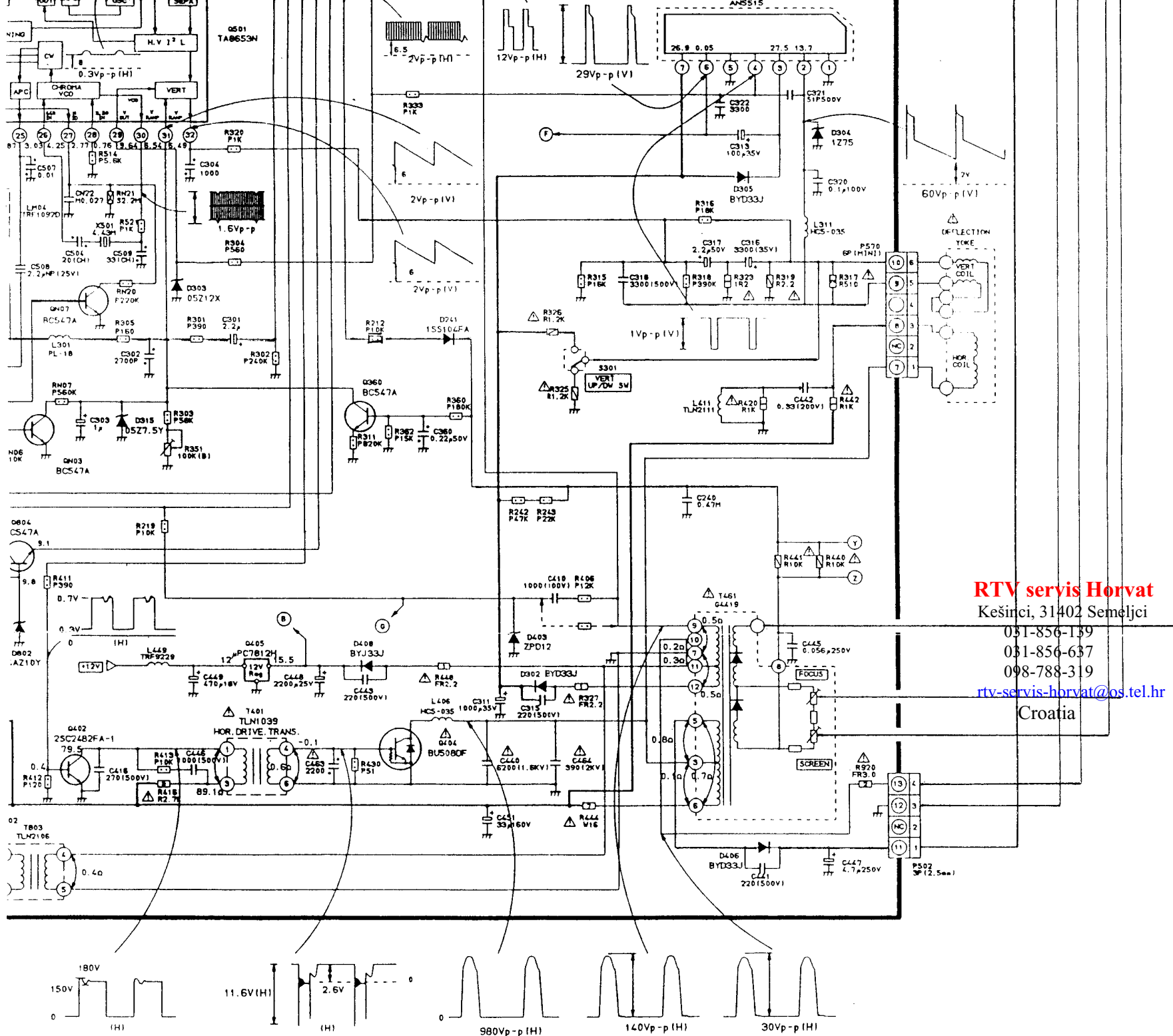

RTV servis Hrvat

Kešinci, 31402 Semeljci

031-856-139

031-856-637

098-788-319

rtv-servis-hrvat@os.tel.hr

Croatia